

Instruction and installation
manual for your new Infinity
F.E.T. Preamplifier.

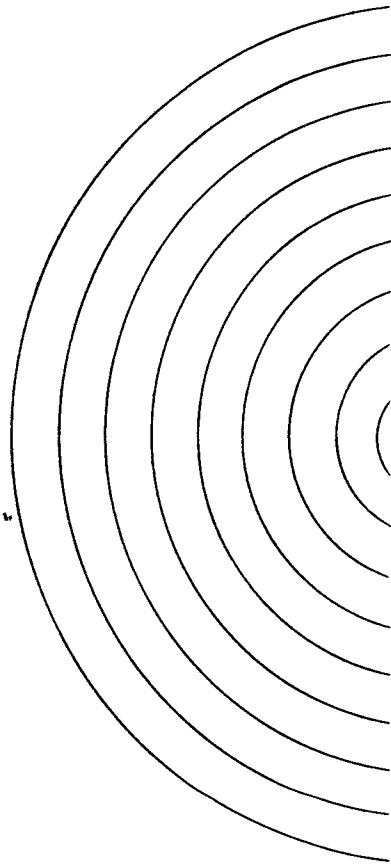

Congratulations! With the purchase of your Infinity High Resolution FET Preamplifier, you have joined the elite of sophisticated music and sound perfectionists. Infinity has put years of experience and many thousands of hours of work into the development of this preamplifier so that we are able to bring you the finest in sound reproduction. In order that you may realize the full potential of your new FET Preamplifier, attention must be given to proper installation. After opening the cartons, carefully examine your preamplifier, checking for possible freight damage. If there is damage, contact your dealer immediately.

Related Components

Selection of related components for use with the Infinity High Resolution FET Preamplifier is the prime factor in assuring the best performance of your system. Any defect or incompatibility in related components will cloud the potential of your new preamplifier. If you should have any questions regarding the compatibility of specific components to use with your new Infinity preamplifier, please do not hesitate to contact your dealer or the factory.

Installation Instructions

All questions concerning location of functions are answered in Figure 2. Please refer to Figure 3

for the overall preamplifier dimensions.

Your Infinity FET Preamplifier is equipped with phono connectors (refer to Figure 2. #3-12 & 16-25) for all audio inputs and outputs. Following is a block diagram of the necessary connections for two tape decks, two phonos, tuner, amplifier and speakers to your preamplifier. A binding post (Fig. 2 #27) is provided for ground connections to the chassis. For maximum performance with minimum additional distortion noise, keep all audio leads that interconnect the various components as short as possible. Make sure that the power source you plan to use (A.C. from your local power company) matches the label on the rear, lower left of the preamplifier.

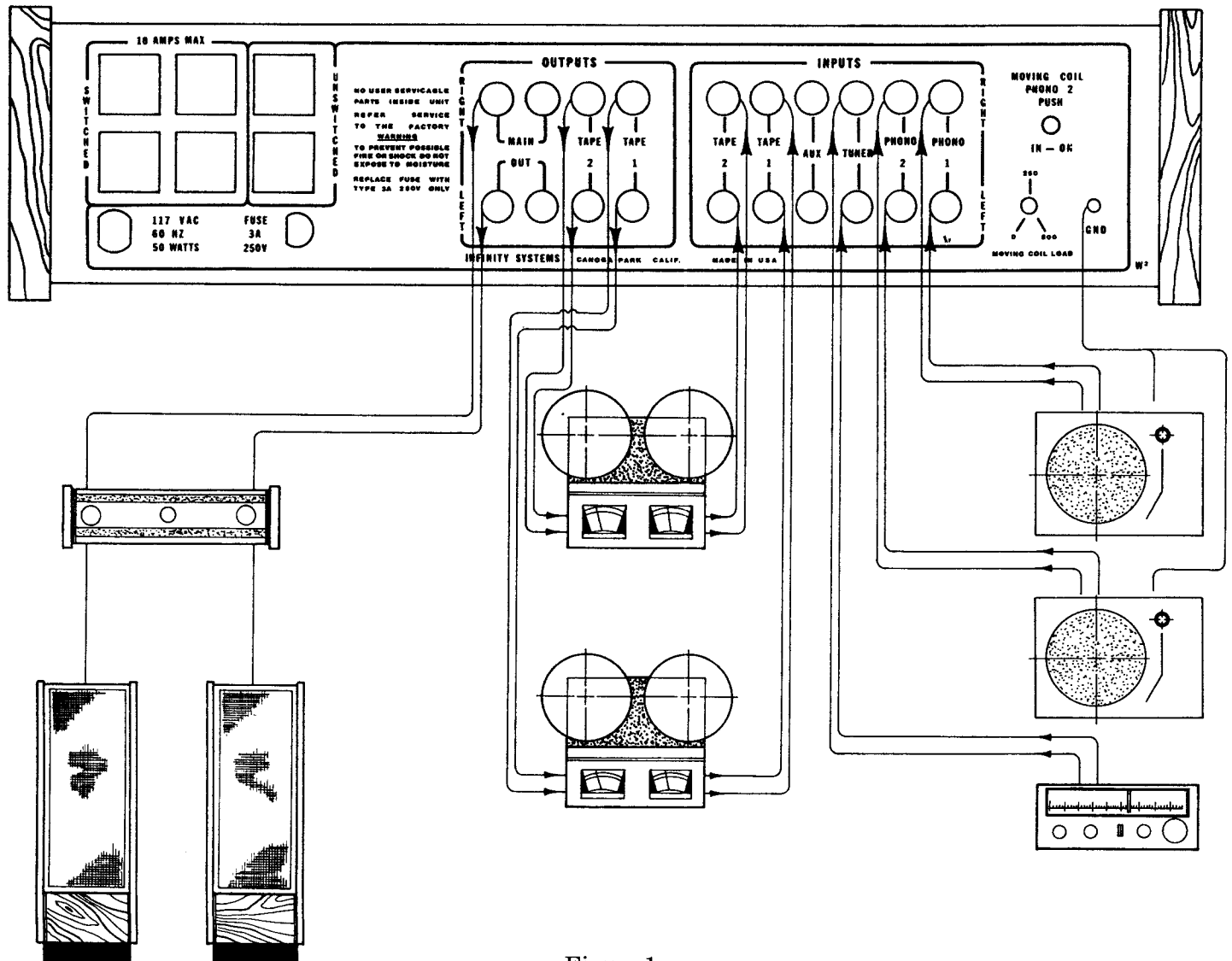

Figure 1

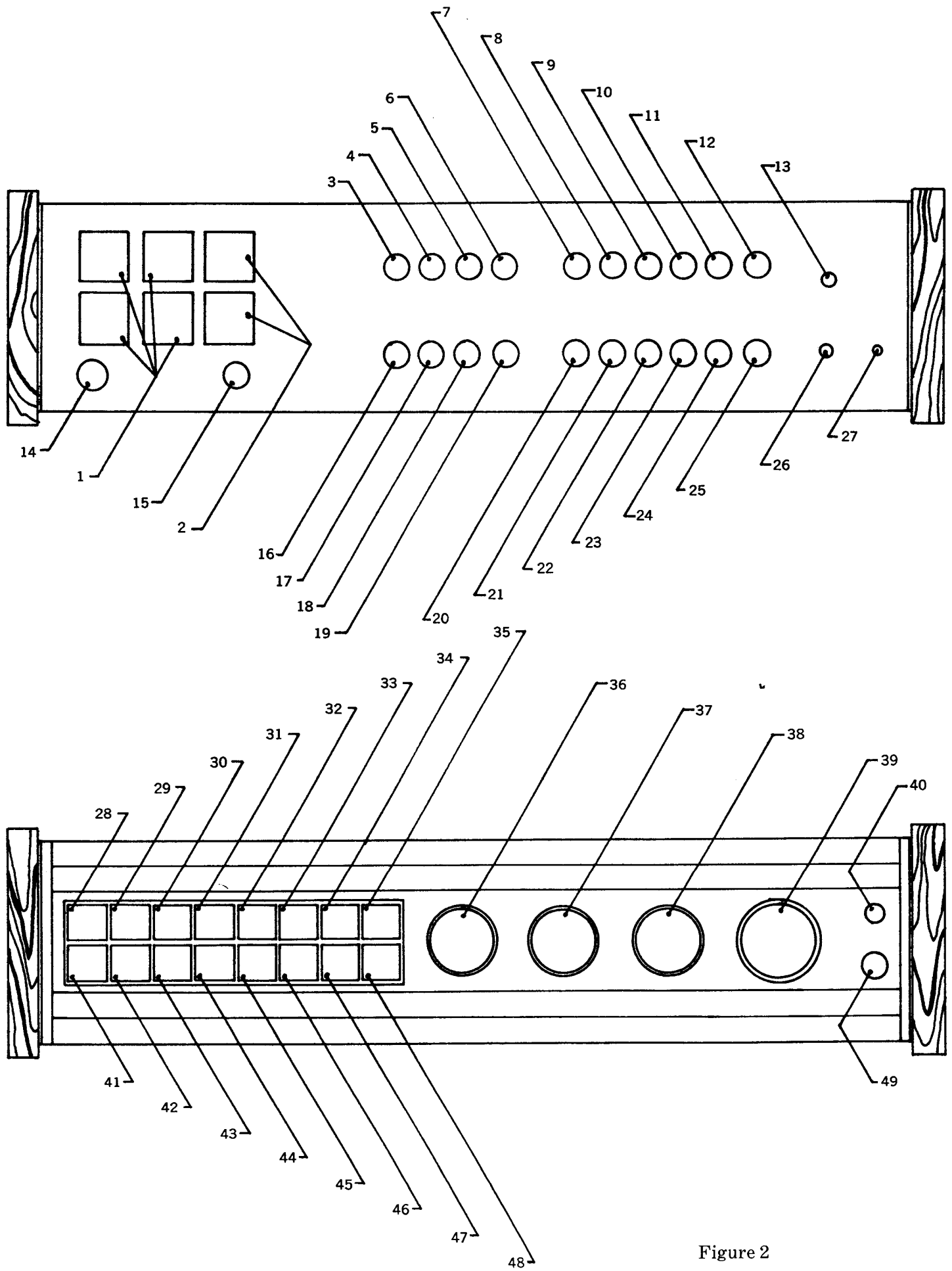

Figure 2

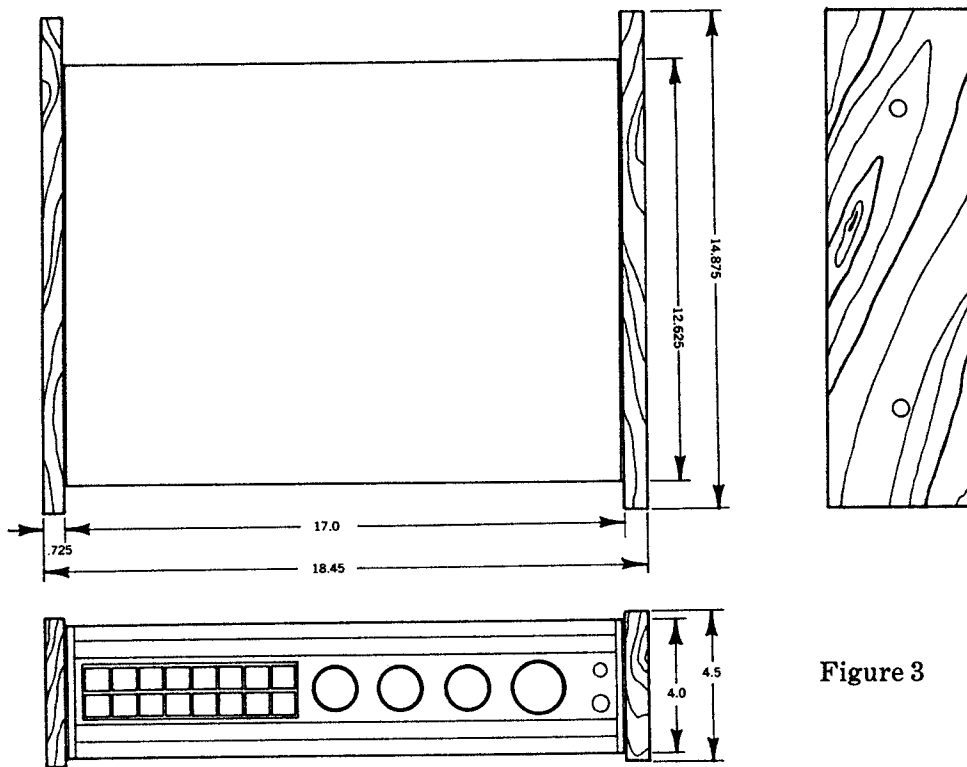
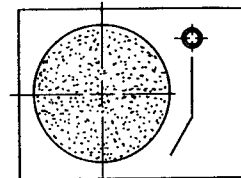
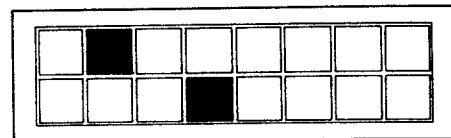

Figure 3

PHONO WITH MOVING COIL ENGAGED:

Gain: 20 db over phono
 Overload Point: 7 mv @ 1 KHz
 Maximum Output: 7 V RMS (at tape monitor)
 Frequency Response: -3 db @ 3 Hz and 50 KHz
 Signal to Noise: -70 dbv 300 to 20 KHz
 (gain set at 60 db and input shorted).
 Input Impedance: 0-500 ohms adjustable

To engage the moving coil preamp circuitry, it is necessary to push the button on the back in the upper right-hand corner (Fig. 2 #13). In the same location you will notice a small knob (Fig. 2 #26) notated "0-250-500." This allows for impedance changes in your FET preamp, matching precisely its impedance to that of your moving coil cartridge. Refer to your moving coil cartridge's instruction manual for the proper input impedance requirements.



Functions Explained

Following each of the functions explanations will be drawings showing button sections necessary to be pushed for that particular function to operate. It is necessary for one of the mode switches (Left, Right, Mono, Stereo, Rev. — See Fig. 2 #41-45) to be activated in order that the preamp will have output.

into or out of; lowering or raising the arm of the turntable when you are switched into any phono circuit. With its high gain potential and the ease at times to forget the position of the gain knob, it is quite possible with a resultant high power transient, to do irrevocable damage to your speaker system.

PHONO SECTION

PHONO 1:

(Fig. 2 #28)

SPECIFICATIONS FOR PHONO:

Gain: 40 db @ 1 KHz
 Overload Point: 70 mv @ 1 KHz
 Maximum Output: 7 V RMS (at tape monitor)
 Frequency Response: -3 db @ 3 Hz and 50 KHz
 Signal to Noise: -82 dbv
 Input Impedance: 47K
 Intermodulation Distortion: .05% @ 2 Volts out
 Harmonic Distortion: .05% @ 2 Volts out

The leads used to connect the turntable to your Infinity preamp (See Fig. 2 #12 & 25) should be kept as short as possible (or in accordance with your turntable's or cartridge's instructions) to avoid undue increases in hum or noise. As always, extreme caution is advised when plugging

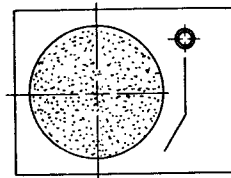
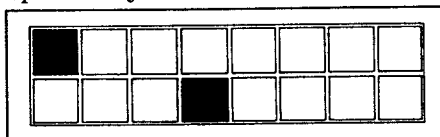

PHONO 2:
 (Fig. 2 #11, 24 & 29)

Specifications for Phono 2 are the same as for Phono 1, except for its optional addition of circuitry allowing for use of a moving coil cartridge, minus the usual external preamp or matching transformer.

LINE SECTION

LINE SECTION:

Gain: 20 db
 Maximum Output: 7 V into 10 K
 Frequency Response: -3 db @ 2 Hz and 100 KHz
 Signal to Noise: -90 dbv
 Input Impedance: 50 K
 Recommended Load: Greater than 10 K
 Intermodulation Distortion: .02% @ 2 Volts out
 Harmonic Distortion: .05% @ 2 Volts out

Because all the remaining possible inputs are switched through the "line section" of the preamplifier, there will be no further mention of its specifications.

TUNER
 (Fig. 2 #10, 23 & 30):

Allows you, via internal switching, to route tuner outputs through the preamplifier's "line section" providing the required gain to drive the power amplifier.

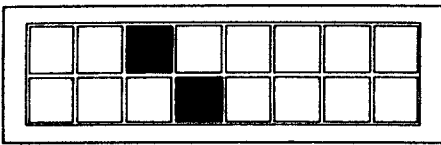

AUX
(Fig. 2 #9, 22 & 31):

Provides same function as tuner input giving you the option to route still another input; possibly another tuner, cassette deck, maybe even the audio from your television receiver, through the preamp.

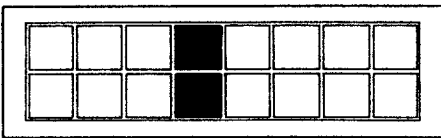

TAPE 1
(Fig. 2 # 6, 8, 19, 21 & 32):

Routes outputs from tape machine No. 1 to preamp line section.

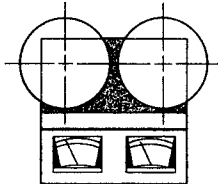
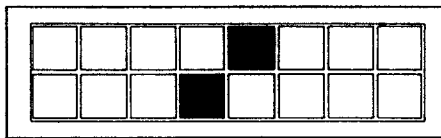

TAPE 2
(Fig. 2 #5, 7, 18, 20 & 33):

Routes outputs from tape machine No. 2 to preamp line section.

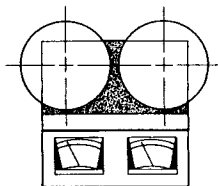
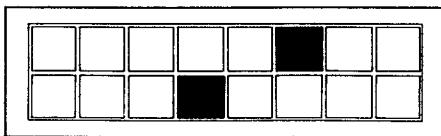

TAPE MON. 1
(Fig. 2 #34):

Your Infinity preamplifier has monitoring facilities allowing you to monitor your recordings as well as provide the necessary internal patchwork for direct tape machine to tape machine connections. This internal switching is done without additional circuitry, eliminating any possible signal degradation. Engaging any of the source buttons (Phono 1, Phono 2, Tuner, Aux, Tape 1, Tape 2) routes its low level signal directly to the outputs marked Tapeout (Fig. 2 #5, 6, 18, 19). These outputs are unaffected by the tone control circuits, mode switches, balance or main volume controls. Activating the tape monitor switch enables you to insert your tape machine in series between the low level section and the line section of the preamp. The example below shows the button sequence required to make a dub from tape machine 1 to tape machine 2 while monitoring tape machine 2. It should be noted that in this example tape machine 1 could be replaced with any of the other source inputs (Phono 1, Phono 2, Tuner, Aux), except tape machine 2.

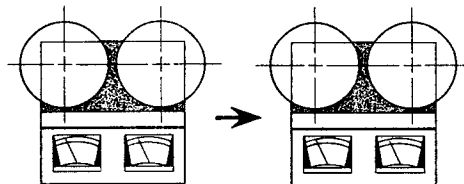
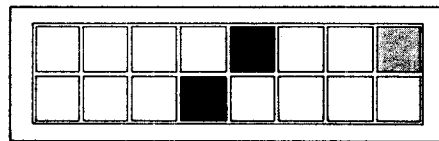

TAPE MON. 2
(Fig. 2 #35):

Tape monitor 2 functions exactly the same as tape monitor 1. The below example is the same as above with the exception that tape machine 2 is the one that could be replaced with any of the other sources (except, of course, tape 1). This enables complete back and forth dubbing and monitoring with no change in your patch.

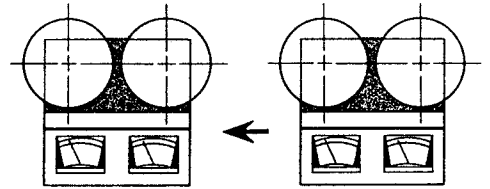
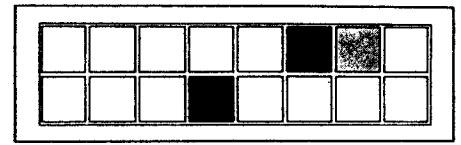

MODE SWITCHES

LEFT
(Fig. 41):

This function routes a single left channel input to both left and right outputs.

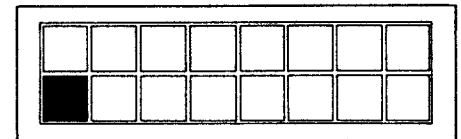

RIGHT
(Fig. 42):

This function routes a single right channel input to both left and right outputs.

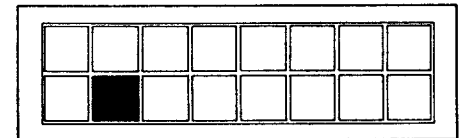

MONO
(Fig. 2 #43):

This function combines both left and right inputs then routes them to both left and right outputs.

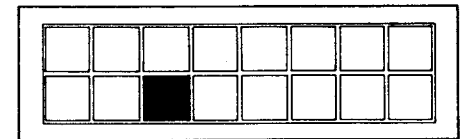

STEREO
(Fig. 2 #44):

Left input goes to left output, right input goes to right output.

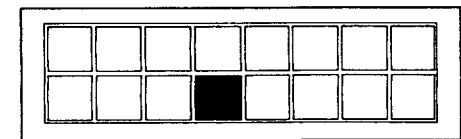

REV

(Fig. 2 #45):

Left input goes to right output.
Right input goes to left output.

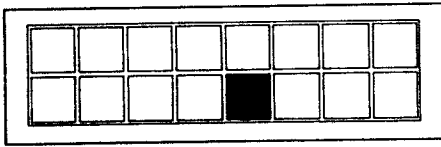

TONE CONTROLS

Note: In order that the tone control circuits will function, the Tone Control Button (Fig. 2 #48) must be activated.

LO TURNOVER

(Fig. 2 #46):

Allows for a lower equalization turnover frequency than with just the Tone Control button engaged, resulting in a much more subtle equalization of the signal affecting only the lowest lows. See graph below.

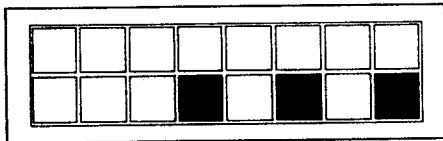

HI TURNOVER

(Fig. 2 #47):

Allows for a higher equalization turnover frequency than with just the Tone Control button engaged, resulting in a much more subtle equalization of the signal affecting only the most sibilant of highs. See graph below.

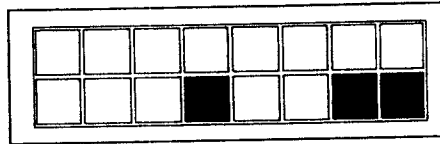

TONE CONTROLS

(Fig. 2 #48):

Deactivates or disengages the tone control circuits of the preamp. The advantage being that you can completely disconnect the circuit from the preamp, resulting in lower distortion, noise, etc.

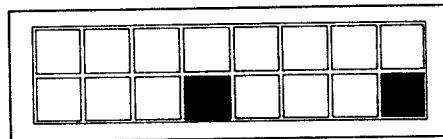

BASS & TREBLE CONTROLS

(Fig. 2 #36 & 37):

Provides the variable control necessary for the adjustment of low frequencies and/or high frequencies relative to the middle frequencies. The curves on the preceding graph are with the Bass and Treble controls either full up or all the way down.

BALANCE CONTROL

(Fig. 2 #38):

This potentiometer is used to precisely set channel balance for correct stereo imaging.

GAIN CONTROL

(Fig. 2 #39):

Adjusts volume at the main outputs (Fig. 2 #3, 4, 16 & 17) of both channels simultaneously.

ON/OFF SWITCH

(Fig. 2 #40):

Turns the household A.C. on and off providing a ten to fifteen second delay on the audio outputs avoiding possible turn on pulses from the preamp from damaging the speakers. This switch also controls the A.C. outlets on the back marked "Switched" (Fig. 2 #1). They are not included in the delay circuitry. Make sure that your projected power consumption through these outlets does not exceed 10 amps (1170 watts @ 117 VRMS 60 Hz). The A.C. outlets labeled "unswitched" (Fig. 2 #2) will remain "hot" as long as the preamp is plugged in.

HEADPHONE JACK

(Fig. 2 #49)

Accepts all standard stereo headphone jacks. When your headphones are plugged in the main outputs to the power amplifiers are disconnected.

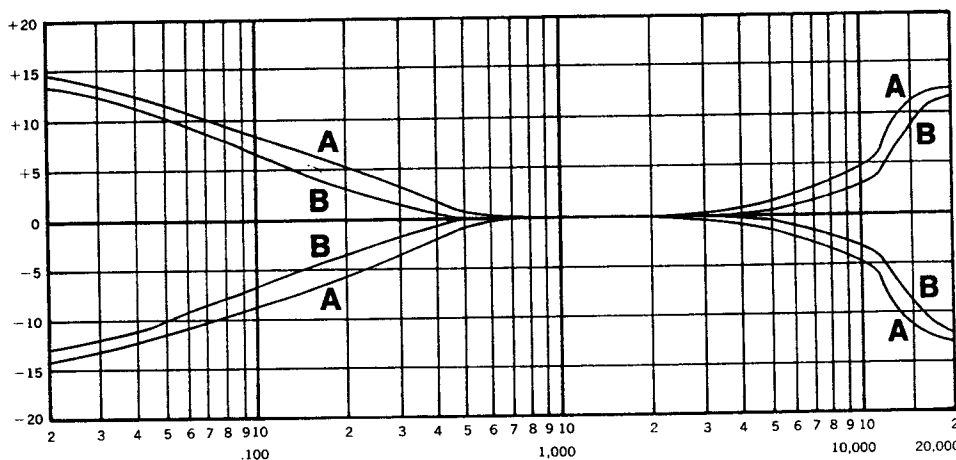

Line 'A' represents a typical Preamp's frequency response with neither the hi-turn or the lo-turn engaged, with tweeter and/or bass controls set at maximum and/or minimum.

Line 'B' represents a typical Preamp's frequency response with both the hi-turn or the lo-turn engaged, with tweeter and/or bass controls set at maximum and/or minimum.

Block Diagram & Specifications

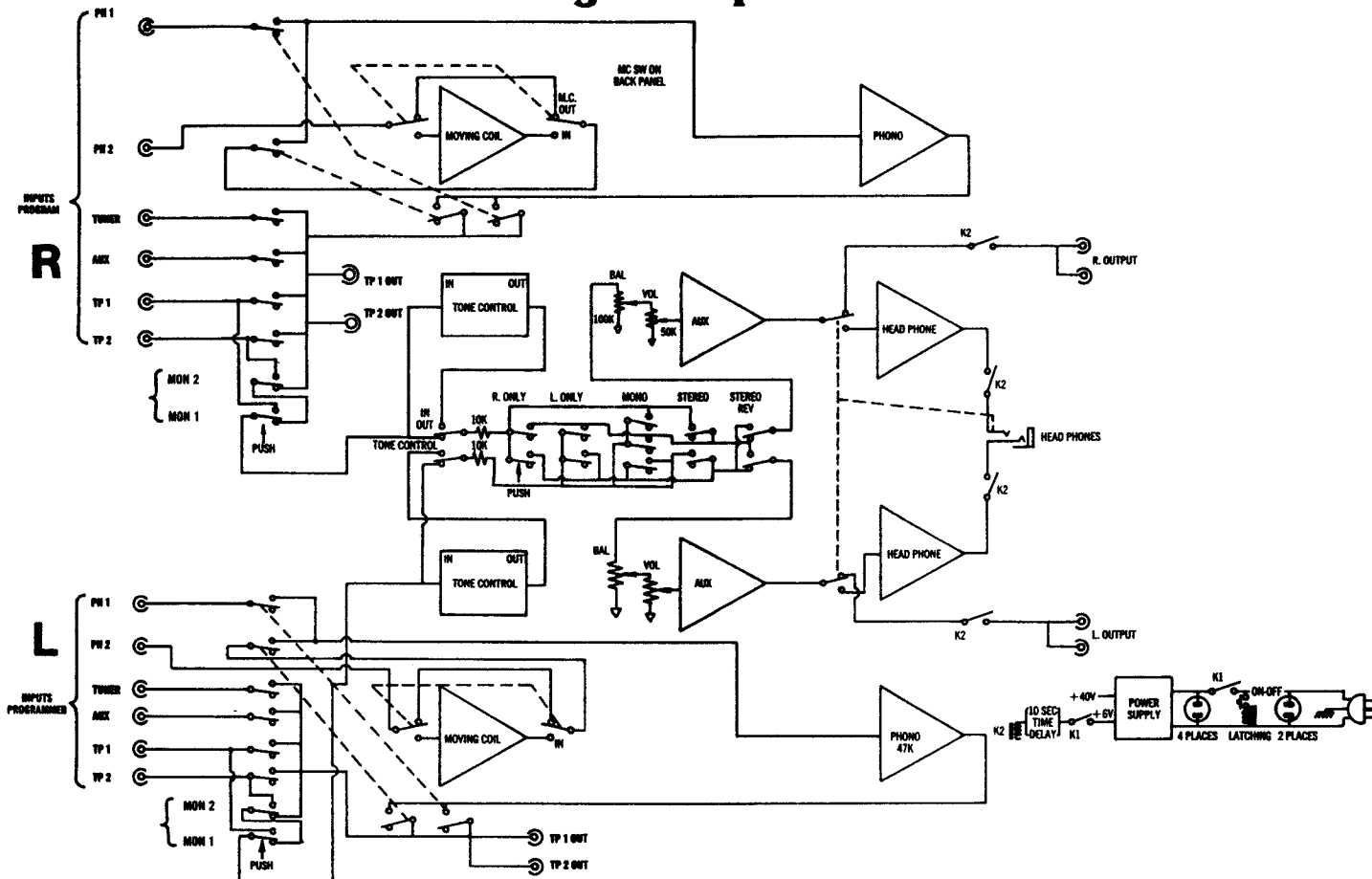

FREQUENCY RESPONSE

PHONO:

- ± .2 db of RIAA Equalization curve,
- 3 db at 3 Hz and 50 KHz.

PHONO WITH MOVING COIL ENGAGED:

- 3 db at 3 Hz and 50 KHz.

LINE SECTION:

- ± .1 db 20 Hz to 100 KHz,
- 3 db at 1 Hz and 230 KHz.

DISTORTION

Intermodulation at 2 volts out.

- | | |
|---------------|------|
| PHONO: | .05% |
| LINE SECTION: | .02% |

Harmonic: (At 2 volts out).

- | | |
|---------------|------|
| PHONO: | .05% |
| LINE SECTION: | .05% |

SIGNAL TO NOISE

PHONO:

- 82 dbv

PHONO WITH MOVING COIL ENGAGED:

- 70 dbv 300 to 20 KHz
- (gain set at 60 db and input shorted).

LINE SECTION:

- 90 dbv

INPUT IMPEDANCE

PHONO:

47 K

PHONO WITH MOVING COIL ENGAGED:

0-500 ohms adjustable

LINE SECTION:

50 K

OUTPUT

Maximum Output: 7 V into 10 K

MINIMUM LOAD IMPEDANCE

Greater than 10 K

POWER SUPPLY

+ 40 V at 500 MA 1% regulated.

POWER REQUIREMENTS

30 Watts at 120 Volts 60 Hz to 400 Hz AC

DIMENSIONS

14⁷/₈" x 18¹/₄" x 4¹/₂"

WEIGHT

26 lbs.

In case you have problems

Please refer to your warranty card for full details on your warranty. Should you suspect trouble in your system, please make sure the problem does not lie in your tape deck, turntable, power amplifier, wiring, etc. The best test to isolate the problem is to interchange components by reversing the wires on the suspect unit, replacing the one in question with one known to be good. If the problem exists in

the good component the trouble must be elsewhere in the system. Thoroughly check your wiring for possible bad connections. If there is still a question in your mind as to the proper functioning of your system, have it checked by your dealer.

Should it become necessary to return a system to the factory, follow the instructions on the warranty card. Note the suspected malfunction. It should be packed in the original packing material. If that is no longer available write

directly to Infinity for packing. Please expect an average of two weeks repair time from the day of receipt at the factory. **DO NOT** ship by bus, Parcel Post or Railway Express (REA). We recommend that individual preamps be returned by truck or an airfreight company and addressed to:

INFINITY SYSTEMS, INC.
7930 Deering Avenue
Canoga Park, CA 91304
Phone: (213) 883-4800

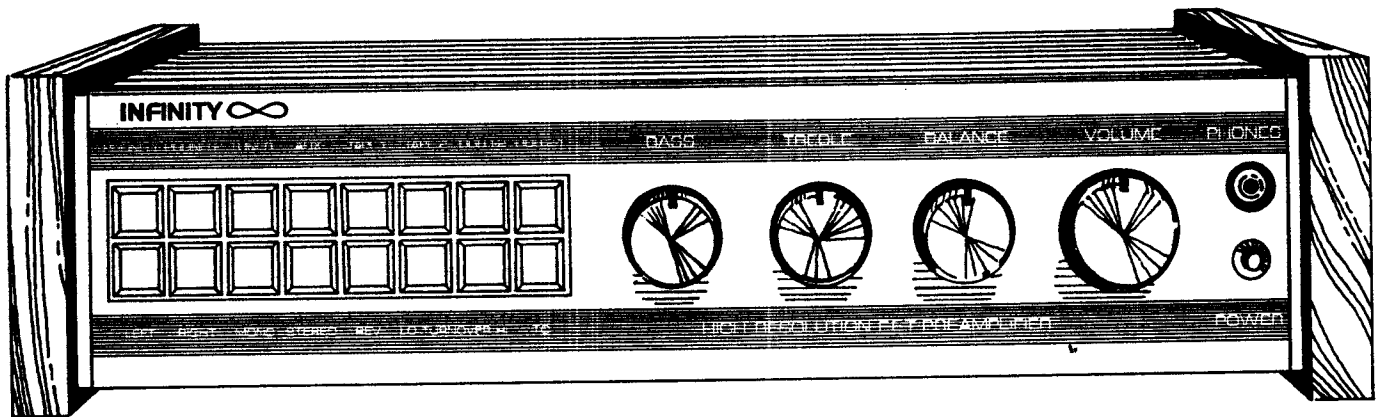

 Infinity

We get you back to what it's all about. Music.