

AMP LEFT

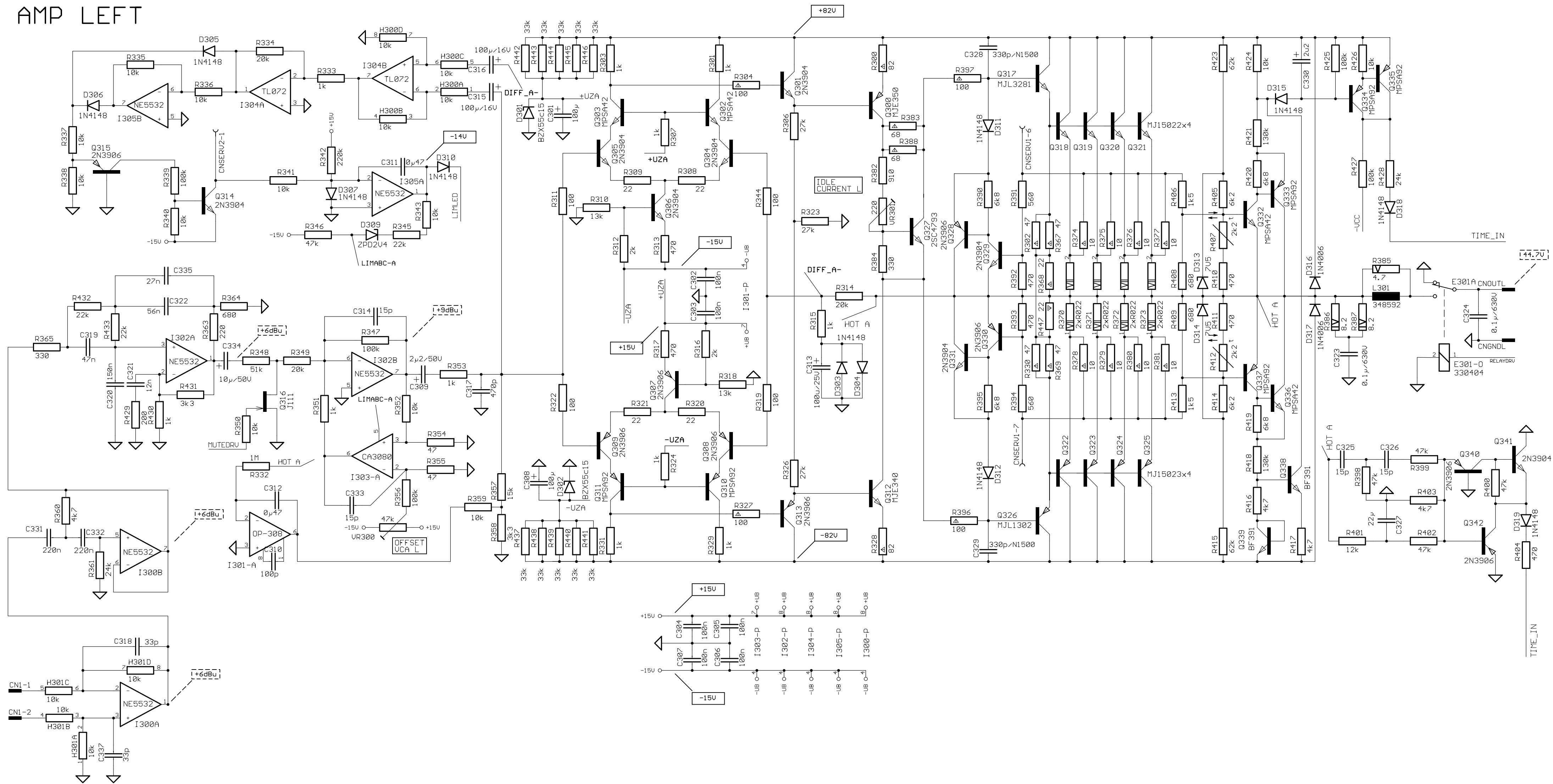

- POWER RESISTOR 5 WATT
- POWER RESISTOR 4 WATT
- DC VOLTAGE MEASURED WITH VOLTMETER 100kOHM/V
- AC VOLTAGE 1000 HZ, MEASURED WITH UTVM
- SAFETY COMPONENT, FLAMEPROOF RESISTOR (MUST BE REPLACED BY ORIGINAL PART)

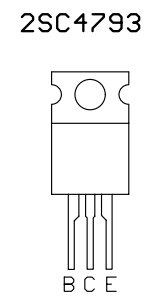
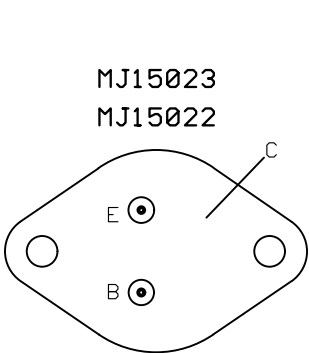
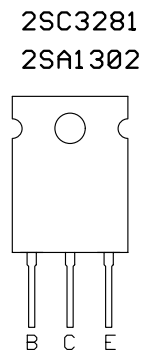
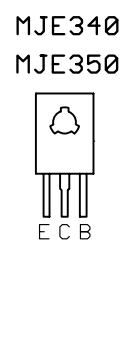
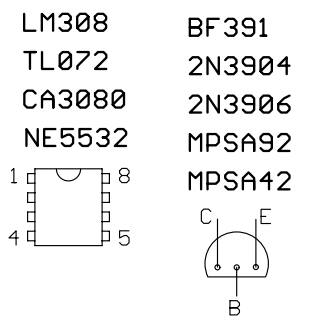
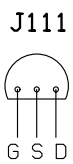

ALTERATIONS RESERVED!

K	I	H	G	F	E	D	C	B	A	ISSUE	REVISION	DATE	NAME	
157/99	145/99	85/99	18/99	6/99	72/97	62/97	57/97	47/97	NULLSERIE					
13.12	24.11	13.07	02.99	22.01	11.97	10.97	09.97	09.97	09.97					
Lang	Lang	Lang	csc	Stangl	Lang	Taffner	Lang	Lang	Lang					
Last modified:			DATE		NAME		APP'D							
13.12.1999 10:48:34			06.97		Taffner									
Last plotted:			DATE		NAME									
03.07.2000 10:21:57			06.97		Taffner									

84169H Power Amplifier Left

CIRCUIT DIAGRAM 1/3

354 011 2-

PM1000/1600/PSX1000/1600

EVI AUDIO