

Accuphase

CLASS A STEREO POWER AMPLIFIER

A-30

- Pure Class A operation delivers quality power: 30 watts x 2 into 8 ohms
- Power MOS-FET output stage features triple parallel push-pull configuration
- Instrumentation amplifier principle
- Further improved MCS+ circuit topology
- Current feedback combines operation stability with outstanding sound
- Bridged mode allows upgrading to true monophonic amplifier
- Massive transformer rated for 400 VA
- 4-step gain control





Pure Class A power amplifier using power MOS-FET devices – Fully balanced signal paths as found in high-quality instrumentation amplifiers. Further refined MCS+ topology and current feedback design result in even better S/N ratio, distortion, and other performance parameters. Robust power supply and power MOS-FET devices in triple parallel push-pull configuration sustain an amazing 150 watts per channel into ultra-low 1-ohm impedance loads (with music signals).

Pure Class A power amplifiers from Accuphase have long been blending the purity of class A operation with the superior performance of power MOS-FETs. While building a string of outstanding amplifiers, Accuphase has accumulated a store of technical know-how that is second to none. The latest in this series, the A-30 is a pure class A stereo power amplifier based on the advanced technology of the model A-60.

The A-30 employs the so-called instrumentation amplifier principle throughout. The signal handling stages feature further improved MCS+ topology and the renowned current feedback approach. This has resulted in electrical characteristics that surpass even the demanding standards set by its predecessors. Employing only highest grade materials and strictly selected parts, the A-30 pursues the two most important goals of an amplifier: very low output impedance (Note 1) and constant drive voltage (Note 2).

The output stage of the A-30 features power MOS-FET devices renowned for their excellent sound and superior reliability. Because they have negative thermal characteristics, there is no danger of thermal "runaway" as exists with bipolar transistors. Operation remains totally stable even when the

amplifier is running hot. Driving these devices in pure class A assures high-definition sound that brings out the finest nuances in the music.

In pure class A operation, the power supply delivers a steady current, regardless of the presence or absence of a musical signal. This means that the amplifier remains unaffected by fluctuations in voltage and other external influences. On the other hand, it also means that the output stage generates considerable thermal energy. In the A-30, this is dissipated effectively by large heat sinks which provide ample capacity to remove the heat produced by the internal circuitry.

The heavy-duty power supply easily sustains output levels of 120 watts into 2 ohms, 60 watts into 4 ohms, or 30 watts into 8 ohms (per channel). This linear progression demonstrates that the amplifier will be capable to drive even speakers with very low impedance ratings or with pronounced impedance fluctuations. Stability remains excellent at all times. The amplifier also has the necessary reserves to handle musical transients that require considerable power in an instant. If even higher power is required, bridged mode turns the A-30 into a high-output monophonic power amp.

Instrumentation amp configuration allows fully balanced signal paths

The A-30 features a new "instrumentation amplifier" principle whereby all signal paths from the inputs to the power amp stage are fully balanced. This results

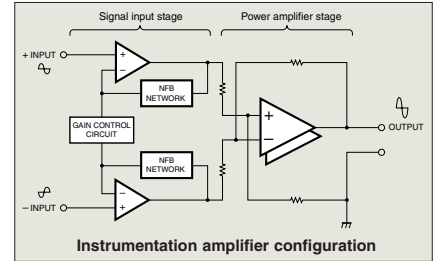

in excellent CMRR (Common Mode Rejection Ratio) and minimal distortion. Another significant advantage is that external noise and other external influences are virtually shut out. The result is a drastic improvement in operation stability and reliability.

Further refined MCS+ topology for even lower noise

Accuphase's original MCS (Multiple Circuit Summing)

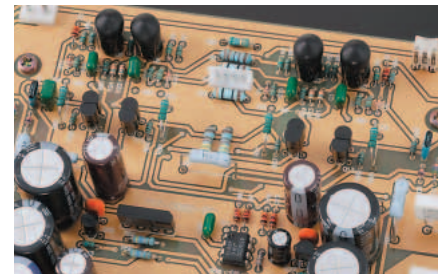

principle uses a number of identical circuits connected in parallel to achieve superior performance characteristics. MCS+ is a further refined version of this approach. Improvements in the bias circuitry of the input-stage buffer amplifier result in greater

stability. This in turn makes it possible to extend the parallel operation approach to the class A drive stage of the current/voltage converter, thereby further lowering the noise floor.

Power MOS-FET output stage with triple parallel push-pull power units delivers 120 watts into 2 ohms, 60 watts into 4 ohms, or 30 watts into 8 ohms with outstanding linearity

The output stage (Figure 1) uses power MOS-FETs. Three pairs of these devices are arranged in a parallel push-pull configuration for each channel. The result is stable operation with ideal power linearity even down to ultra-low impedances. The maximum power dissipation of one MOS-FET is 130 watts, but the actual power load per pair is much

Note 1: Low amplifier output impedance

The load of a power amplifier, namely the loudspeaker, generates a counterelectromotive force that can flow back into the amplifier via the NF loop. This phenomenon is influenced by fluctuations in speaker impedance and interferes with the drive performance of the amplifier. The output impedance of a power amplifier should therefore be made as low as possible by using output devices with high current capability. This absorbs the counterelectromotive force generated by the voice coil and prevents the occurrence of intermodulation distortion.

Note 2: Constant drive voltage principle

Even in the presence of a load with wildly fluctuating impedance, the ideal power amplifier should deliver a constant voltage signal to the load. Figure 2 shows the results of actual output voltage/output current measurements at different load impedances for the A-30. It can be clearly seen that output voltage is virtually constant at various loads, which means that current increases in a linear fashion. Actual measurements of clipping power have yielded the following figures, which impressively demonstrate the more than ample performance of the A-30: 1 ohm: 175 watts, 2 ohms: 142 watts, 4 ohms: 94 watts, 8 ohms: 58 watts.

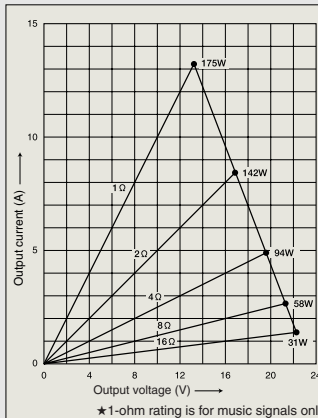

Fig. 2 Load impedance vs. output power (Output voltage/output current)
★ 1-ohm rating is for music signals only.

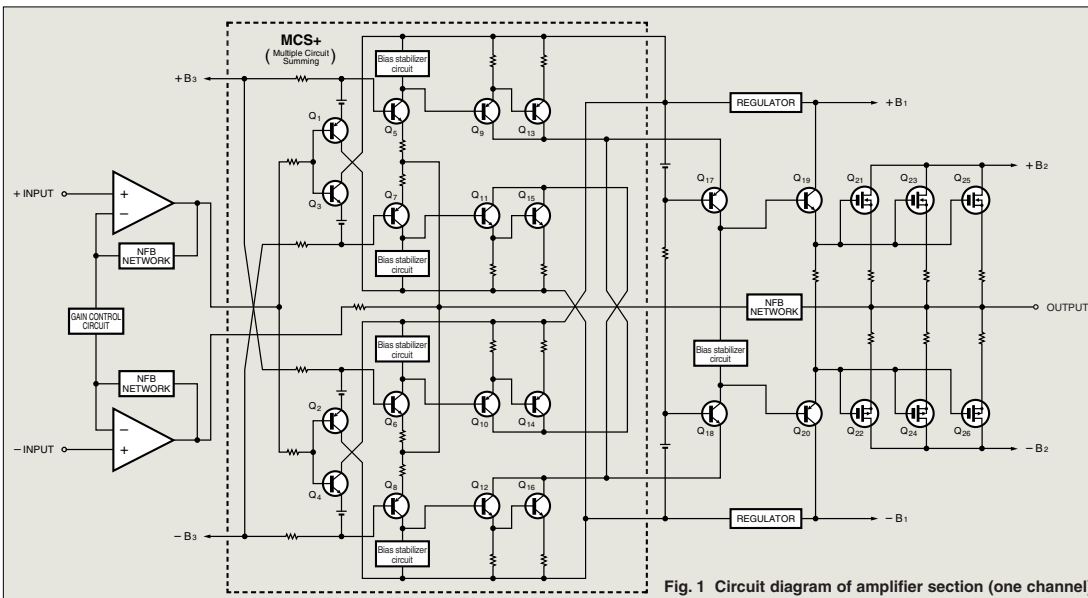
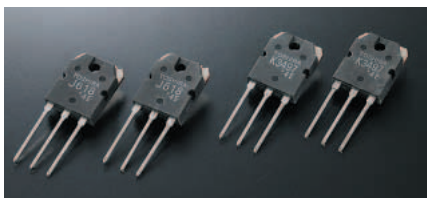

Fig. 1 Circuit diagram of amplifier section (one channel)



lower, so that each device is driven only in its low-power range where linearity is excellent.

A music signal consists of a continuous succession of pulse waveforms. To prevent clipping on occasional momentary high-level pulses, the maximum clipping level of the A-30 is set to 50 watts per channel into 8 ohms (sine wave output).

Current feedback circuit topology assures excellent phase characteristics in high range

In the A-30, the signal current rather than the more conventionally used voltage is used for feedback. Since the impedance at the current feedback point (current adder in Figure 3) is very low, there is almost

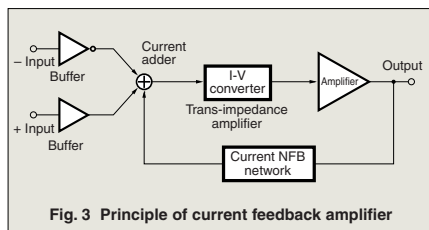

Fig. 3 Principle of current feedback amplifier

no phase shift. Phase compensation therefore can be kept at a minimum. A minimal amount of NFB results in maximum improvement of circuit parameters. The result is excellent transient response and superb sonic transparency,

coupled with utterly natural energy balance. Figure 4 shows frequency response for different gain settings of the current feedback amplifier. The graphs demonstrate that response remains uniform over a wide range.

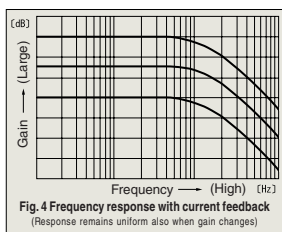

Fig. 4 Frequency response with current feedback (Response remains uniform also when gain changes)

Robust power supply with large power transformer and high filtering capacity

In any amplifier, the power supply plays a vital role since it acts as the original source for the output delivered to the speaker. The A-30 employs a large and highly efficient 400 VA power transformer. It is

housed in an enclosure filled with a material that transmits heat and absorbs vibrations. This completely prevents any adverse influences on other circuit parts.

Two aluminum electrolytic capacitors rated for 47,000 μ F each serve to smooth out the pulsating direct current from the rectifier, providing more than ample filtering capacity.



■ Power amplifier assembly with three parallel push-pull power MOS-FET pairs per channel mounted directly to large heat sink, MCS+ circuitry, and current feedback amplifier



Instrumentation amp type gain control minimizes residual noise

The gain control switches gain in the first amplification stage that uses an instrumentation amp design. Four settings are available (MAX, -3 dB, -6 dB, -12 dB). With this approach, reducing gain also results in reduced noise. This is especially beneficial when using highly efficient speaker systems where the noise floor could be a problem.



Bridged connection allows upgrading to a true monophonic amplifier with 300 watts into 2 ohms (music signals only), 240 watts into 4 ohms, and 120 watts into 8 ohms

Operation in bridged mode results in a monophonic amplifier with four times the power output than during stereo operation. This gives effortless dynamic power.

■ **Easy switching between dual mono/stereo/bridged mode**

In the dual mono position of the mode selector, the left-channel signal is supplied to both speaker terminals, which can be used for bi-amping with dedicated low-range and high-range drivers.



■ **Oversize speaker terminals also accept Y lugs and banana plugs**

The sturdy terminals can handle even very large gauge speaker cable. The connectors are made of extruded high-purity brass material and are gold-plated for utmost reliability and minimum contact resistance.



Y lugs and banana plugs can also be used.

■ **Large analog power meters**

■ **Balanced connection prevents induced noise**

■ **PCB copper foil and all major signal path components are gold-plated**

■ **Buttons for meter on/off, meter sensitivity, and input selection**

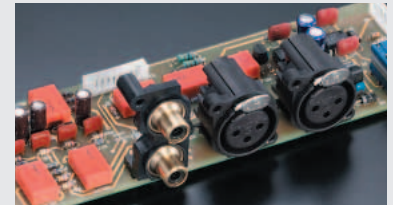

Unbalanced and balanced input connectors

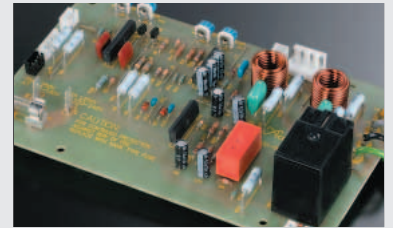

Protection and meter circuit assembly



High-quality, high-reliability parts

■ **Front panel**

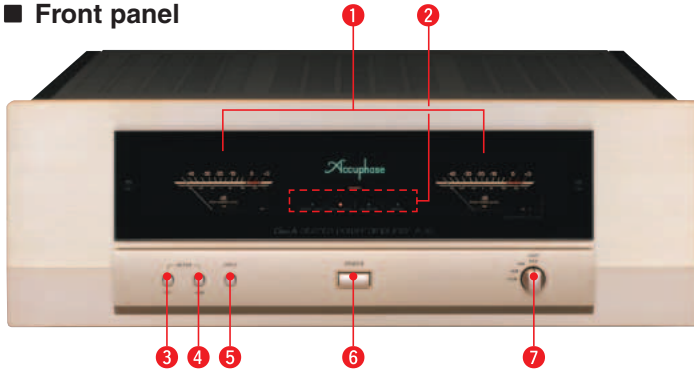

■ **Rear panel**



- 1 Right/left-channel output power meters (dB and % scale)
- 2 Function indicators
METER, -20 dB, UNBALANCED, BALANCED, BRIDGE
- 3 Meter operation/illumination switch ON OFF
- 4 Meter sensitivity selector button (-20 dB)
- 5 Input selector button UNBALANCED BALANCED
- 6 Power switch
- 7 Gain selector
MAX -3 dB -6 dB -12 dB
- 8 Unbalanced inputs
- 9 Balanced inputs
①: Ground
②: Inverted (-)
③: Non-inverted (+)
- 10 Mode selector
DUAL MONO NORMAL BRIDGE
- 11 Right/left-channel speaker output terminals
- 12 AC power supply connector*

Remarks

- * This product is available in versions for 120/230 V AC. Make sure that the voltage shown on the rear panel matches the AC line voltage in your area.
- * The shape of the AC inlet and plug of the supplied power cord depends on the voltage rating and destination country.

■ Supplied accessories: • AC power cord

GUARANTEED SPECIFICATIONS

[Guaranteed specifications are measured according to EIA standard RS-490.]

● **Continuous Average Output Power (20 - 20,000 Hz)**

Stereo operation	150 watts per channel into 1 ohm (*)
(both channels driven)	120 watts per channel into 2 ohms
	60 watts per channel into 4 ohms
	30 watts per channel into 8 ohms
Monophonic operation	300 watts into 2 ohms (*)
(bridged connection)	240 watts into 4 ohms
	120 watts into 8 ohms

Note: Load ratings marked (*) apply only to operation with music signals.

● **Total Harmonic Distortion** Stereo operation (both channels driven)

0.05%, with 2-ohm load
0.03%, with 4 to 16-ohm load
Monophonic operation (bridged connection)
0.05%, with 4 to 16-ohm load

● **Intermodulation Distortion** 0.005%

● **Frequency Response**

At rated output:	20 ~ 20,000 Hz +0, -0.2 dB
At 1 watt output:	0.5 ~ 160,000 Hz +0, -3.0 dB

● **Gain**

28.0 dB (GAIN selector in MAX position)
(stereo and monophonic operation)

● **Gain Settings**

MAX, -3 dB, -6 dB, -12 dB

● **Output Load Impedance**

Stereo operation: 2 to 16 ohms
Monophonic operation: 4 to 16 ohms

[* With music signals, load impedances of 1 Ω (stereo) or 2 Ω (mono) can be driven.]

● **Damping Factor**

150

● **Input Sensitivity (with 8-ohm load, GAIN selector in MAX position)**

Stereo operation:	0.57 V for rated continuous average output of 30 W
	0.11 V for 1 watt output
Monophonic operation:	1.14 V for rated continuous average output of 120 W
	0.11 V for 1 watt output

● **Input Impedance**

Balanced: 40 kilohms Unbalanced: 20 kilohms

● **Signal-to-Noise Ratio (A-weighted, input shorted)**

111 dB (GAIN selector in MAX position)
118 dB (GAIN selector in -12 dB position) at rated output

● **Output Level Meters**

-40 dB to +3 dB (dB/% scale)
Logarithmic scale, with switching capability for meter operation and sensitivity

● **Power Requirements**

AC 120 V/230 V (Voltage as indicated on rear panel) 50/60 Hz

● **Power Consumption**

170 watts idle
260 watts accordance with IEC 60065

● **Maximum Dimensions**

Width 465 mm (18-5/16")
Height 170 mm (6-11/16")
Depth 425 mm (16-3/4")

● **Mass**

21.5 kg (47.4 lbs) net
26.0 kg (57.3 lbs) in shipping carton

• Specifications and design subject to change without notice for improvements.

