

TEAC

SERVICE MANUAL

RX-9 DBX* Unit

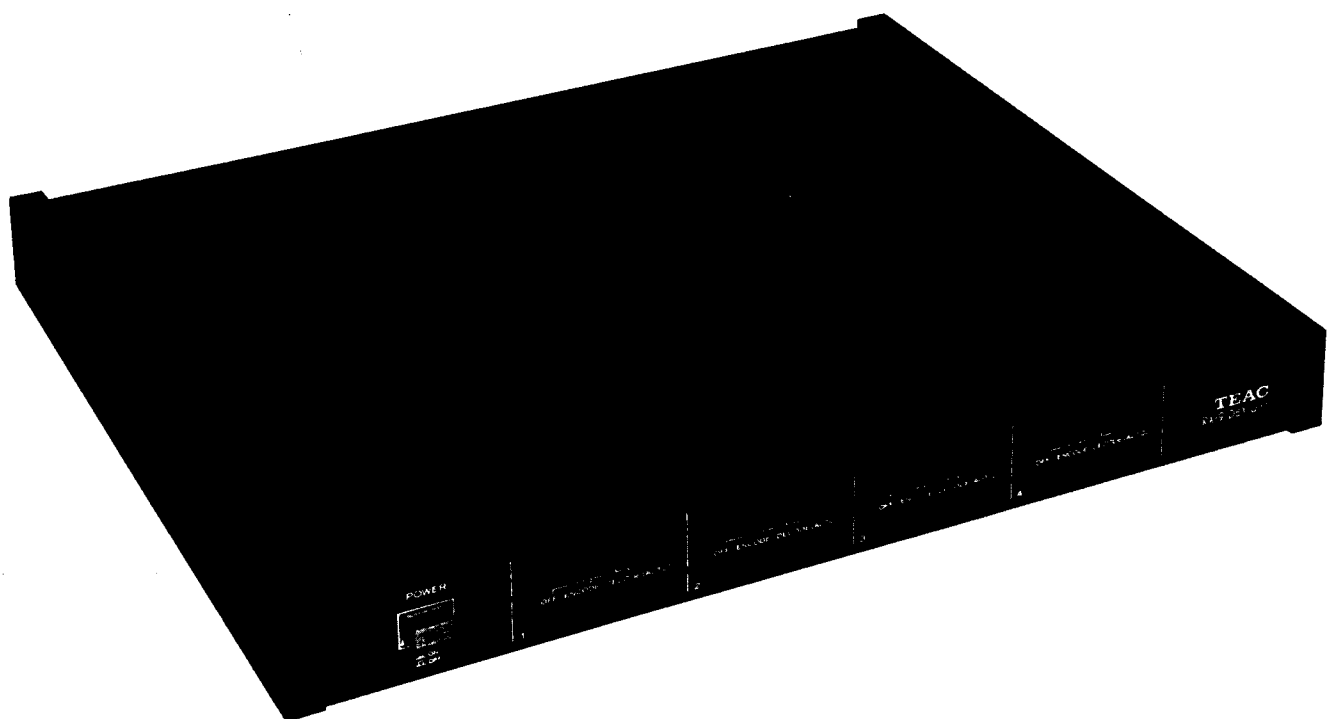

* dbx noise reduction system made under license from dbx, Incorporated. The word dbx and the Symbol are trademarks of dbx, Incorporated.

TEAC CORPORATION

51032540

GENERAL DESCRIPTION

The RX-9 was specifically designed for use only with the TEAC A-3440 open deck or other decks which can provide a suitable power source connection for the RX-9. The adjustment procedures given in this manual can be done independently of any other deck if suitable input power is provided.

This manual also includes a parts list and schematic diagram to assist the service technician in maintaining the RX-9. For additional information concerning operation, connections and dbx system theory, please refer to the RX-9 Owner's Manual.

Please feel free to contact the nearest TEAC Factory Service Department or write directly to a TEAC office, the addresses of which are printed on the back cover of this manual.



TABLE OF CONTENTS

General Description	3
Specifications	4
Test Equipment Required	4
Parts and Adjustment Location	5
Voltage Conversion	5
Testing and Adjustment Procedure	6
Block Diagram	9
Parts List	11~22

SPECIFICATIONS

Number of channels	4 channels (4 Encoder/4 Decoder)
Input (RCV)	Impedance: Greater than 50 k ohms Nominal input level: -10 dB (0.3V) Maximum input Level: Encoder/Decoder Rcv: +16 dB (6.31V)
Output (SEND)	Load impedance: Greater than 10 k ohms Nominal output level: -10 dB (0.3V) Maximum output level: Encoder/Decoder Send: +16 dB (6.31V)
Distortion (back to back)	0.2% max. at 1 kHz
Frequency response (back to back)	40 Hz to 15 kHz ± 1 dB for Encoder 30 Hz to 20 kHz ± 3 dB for Decoder
S/N RATIO (overall)	80 dB (UNWTD), 85 dB (WTD), or better
Channel separation	70 dB, or more at 1 kHz 60 dB, or more at 10 kHz 80 dB, or more at 100 Hz

Power requirement and consumption

Model	Voltage (AC)	Frequency (Hz)	Consumption (W)
U.S.A./CND	117	60	8
AUS/UK	240	50	8
CEE (class II)	220	50	8
General Export	100/117 220/240	50/60	8

Dimensions (WHD)	445 mm x 52 mm x 367 mm (17-1/2" x 2-1/16" x 14-7/16")
Weight	6.2 kg (13.6 lbs)

NOTE: Changes in specifications and features may be made without notice.
Value of "dB" in the Data refers to 0 dB = 1V, except where specified.
If an AC Voltmeter calibrated to 0 dB = 0.775V is to be used, appropriate compensation should be made.

TEST EQUIPMENT REQUIRED

- Oscillator Audio use, distortion less than 0.05% (at 1 kHz) with Output +20 dB (10V)
- Oscilloscope General purpose
- AC Voltmeter -100 dB ~ +30 dB, imp. = > 1M, 25 pF
- Total Harmonic Distortion Meter 100% 0.01% imp. = > 10k with Scope Output terminal
- Multitester General purpose
- Band Pass Filter Required when oscillator distortion is higher than 0.1%

PARTS AND ADJUSTMENTS LOCATION

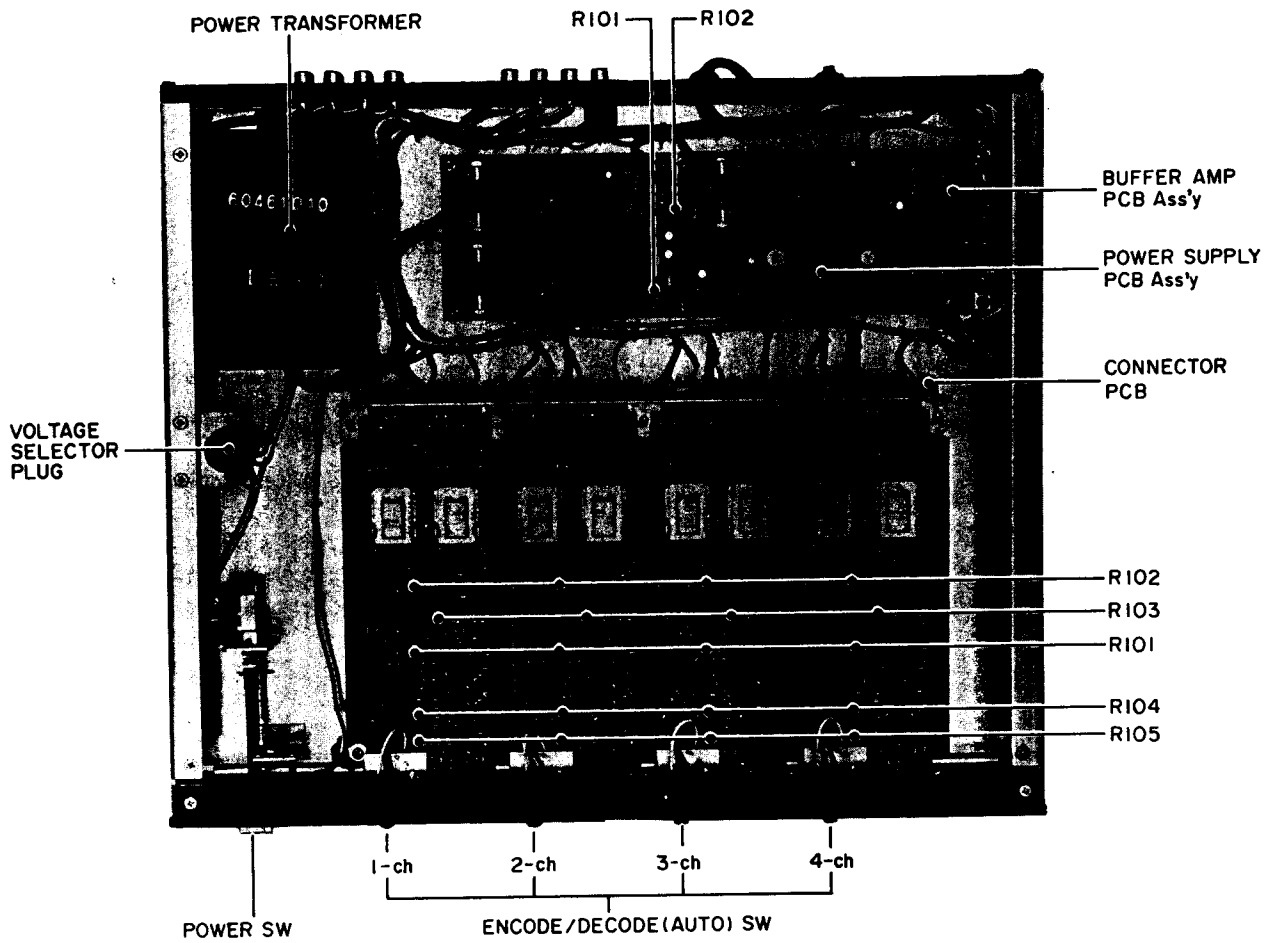

VOLTAGE CONVERSION (General Export Model)

If the AC power line (mains) voltage in your area does not match the AC power requirements indicated on the label attached to this unit or printed on the packing carton, this unit must be adjusted using the following procedure.

FIRST MAKE SURE THE AC POWER CORD IS DISCONNECTED FROM THE AC OUTLET OR POWER SOURCE.

1. Remove the top cover of the unit by removing 5 screws.
2. Pull out the plug and reinsert it so that the desired voltage appears in the Cut-out window of the plug.
3. Replace the top cover of the unit.

TESTING AND ADJUSTMENTS PROCEDURE

1. DC POWER SUPPLY VOLTAGE CHECK

- NOTE:**
- Before applying power, check ENCODE/DECODE (AUTO) SW is in the OFF position.
 - Short between Pin No. 4 and 1 on the CONTROL 6P CONNECTOR.

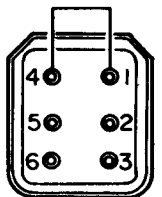

T-1369

Fig. 2

1-1 ADJUSTING DC -15 VOLT SUPPLY

1. Put the ENCODE/DECODE (AUTO) SW in the ENCODE position.
2. Connect a DC Voltmeter (or multimeter), between terminal No.2 and 3 (ground) on CONNECTOR BOARD.
3. If adjustment is necessary, adjust pot R102 for $-15V \pm 0.1$ VDC on POWER P.C.B. Ass'y.

1-2 ADJUSTING DC +15 VOLT SUPPLY

4. Change the Test Point to terminal No. 1 and 3 (ground).
5. Adjust pot R101 for $+15V \pm 0.1$ V.D.C.

NOTE: The -15 Volt Supply must always be adjusted first as this is a voltage tracking type power supply. Since the +15 Volt Supply is referenced to the -15 Volt Supply, the +15 Volt line must always be checked and adjusted when the -15 Volt line is adjusted.

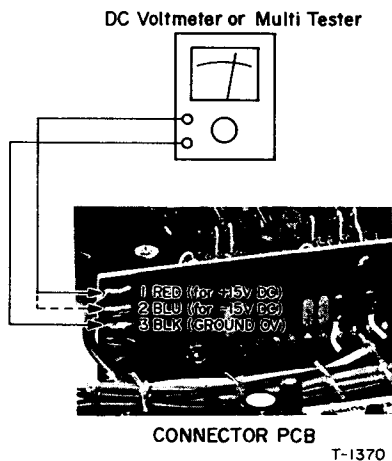

CONNECTOR PCB

T-1370

Fig. 3

2. DBX AMPL. ADJUSTMENT PROCEDURE

NOTE: The following measurement procedure is for channel 1, Repeat the same procedure for channels 2, 3 and 4.

Following check and adj. always keep the short between Pin No. 4 and 1 on CONTROL SIGNAL 6P CONNECTOR.

TEST CONNECTIONS

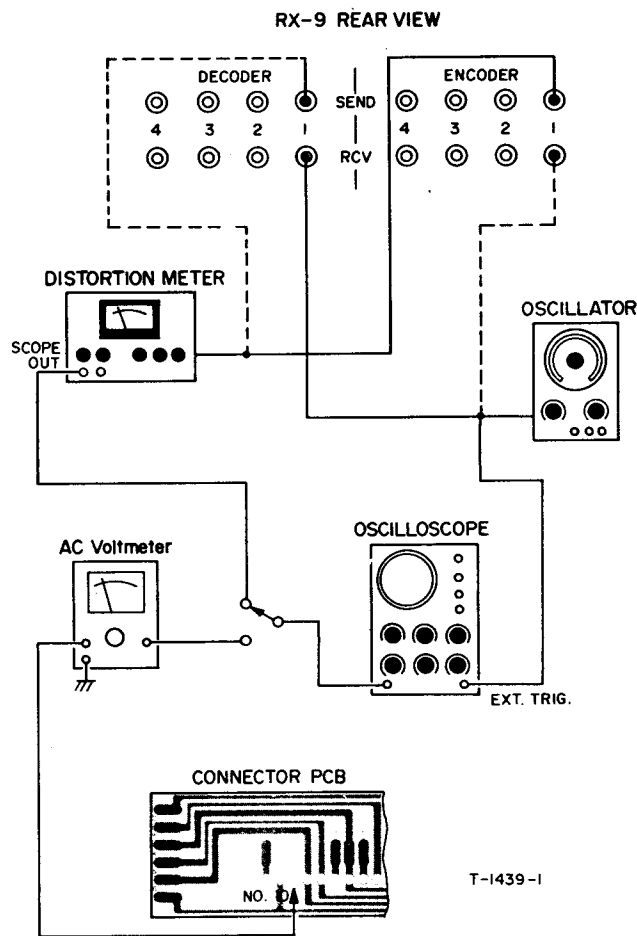

Fig. 4

T-1439-1

2-1 ENCODER ADJ.

ENCODE/DECODE (AUTO) SW ENCODE

2-1-1 NOMINAL LEVEL PRELIMINARY SETTING

1. Apply a 1 kHz -10 dB (0.3V) signal to the ENCODER RCV jack.
2. Adjust R105 for -10 dB (0.3V) \pm 0.2 dB at ENCODER SEND jack.

NOTE: At this point approximate adjustment is O.K.

2-1-2 SYMMETRICAL ADJ.

3. Feed 100 Hz -10 dB (0.3V) to the ENCODER RCV jack.
4. Connect oscilloscope through AC Voltmeter to the terminal No. 10 as shown in Fig. 4.
5. Adjust R103 to obtain a clean 200 Hz sine-wave on the monitoring oscilloscope so that the reading on the AC Voltmeter indicates minimum value of -67.7 dB \pm 1 dB ($46.2\mu\text{V} \sim 367\mu\text{V}$).
See Fig. 5 and Fig. 6.

2-1-3 DISTORTION ADJ.

6. Connect an oscilloscope to ENCODER SEND jack through the distortion meter.
7. Feed 1 kHz -10 dB (0.3V) to ENCODER RCV jack then adjust R101 to obtain the minimum distortion level and a clean 3 kHz sine-wave on the monitoring oscilloscope.
8. Feed 1 kHz (20 dB below the nominal input level) to ENCODER RCV jack, then adjust R102 to obtain a clean sine-wave on monitoring oscilloscope. The distortion level should be minimal.
9. Repeat above procedure (steps 7 and 8) until a clean 3 kHz sine-wave is obtained in both procedures. As a result, distortion level shows the same level in both procedures and it should be minimal. See Fig. 7 and 8.

2-1-4 NOMINAL LEVEL SETTING

With the controls set as described in 2-1-1.

10. Adjust R105 for correct adjustment.

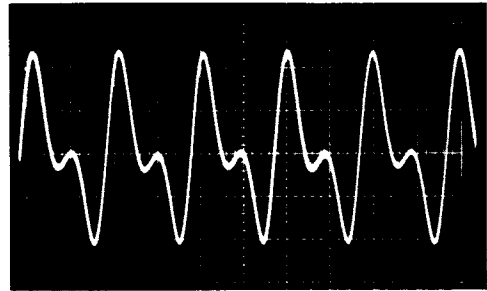

Fig. 5 Incorrect setting of R103

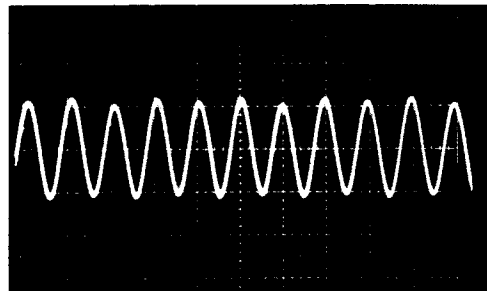

Fig. 6 Proper setting of R103

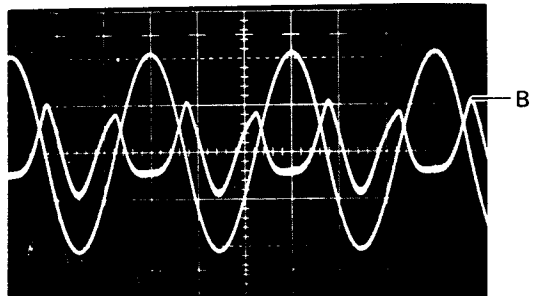

Fig. 7 Incorrect setting of R101 or R102

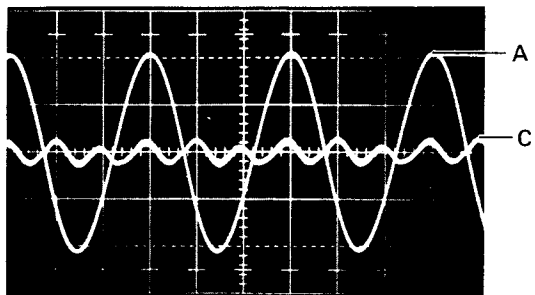

Fig. 8 Proper setting of R101 or R102

- A: 1 kHz sine-wave (Encoder RCV).
- B: Distortion wave form (2 kHz).
- C: 3 kHz sine-wave (minimum distortion level)

2-2 DECODER ADJ.

ENCODE/DECODE (AUTO) SW . . . DECODE (AUTO)

2-2-1 NOMINAL LEVEL SETTING

1. Apply a 1 kHz -10 dB (0.3V) signal to the DECODER RCV jack.
2. Adjust R104 for -10 dB (0.3V) ± 0.2 dB at DECODER SEND jack.

2-3 ENCODER AND DECODER CHECK

2-3-1 S/N CHECK

1. Ground the RCV jacks and measure the residual noise.
2. The noise level as indicated on the AC Voltmeter should be as listed below.

ENCODER	-50 dB (3.16mV) or better UNWTD -55 dB (1.78mV) or better . . . WTD
DECODER	-90 dB (31.6 μ V) or better . UNWTD -95 dB (17.8 μ V) or better WTD

NOTE: This -50 dB/ -90 dB (UNWTD) corresponds to a Signal-to-Noise Ratio of 40 dB/80 dB (minimum); the difference between residual noise of -50 dB/ -90 dB and nominal output level -10 dB (0.3V).

2-3-2 FREQUENCY CHARACTERISTICS CHECK

1. Apply the following three signals at nominal level -10 dB (0.3V) to ENCODER RCV jack (or DECODER RCV).
2. Check the Frequency limits at ENCODER SEND jack (or DECODER SEND). Reference 1 kHz.

SIGNALS	100 Hz	1 kHz	10 kHz
ENCODER	-2.5 dB ± 0.5 dB (794mV to 708mV)	0 (0.3V)	-4.5 dB ± 0.5 dB (631mV to 562mV)

DECODER	$+5$ dB ± 1 dB (1.58V to 2.00V)	0 (0.3V)	$+9$ dB ± 1 dB (2.51V to 3.16V)
---------	--	-------------	--

2-3-3 LINEARITY CHECK

1. Apply a 1 kHz -60 dB (1mV) below nominal level -10 dB (0.3V) to the ENCODER RCV jack.
2. The AC Voltmeter connected to the ENCODER SEND jack should read -30 dB ± 0.5 dB (335mV to 299 mV).
3. Also, apply a 1 kHz $+20$ dB (10V) above nominal level -10 dB (0.3V) to the ENCODER RCV jacks.
4. The AC Voltmeter connected to the ENCODER SEND jacks should read $+10$ dB ± 0.5 dB (2.99V to 3.55V).
5. Repeat the above procedure for DECODER circuit, using the signals in the chart below.

Apply Signal (RCV)	Output reading (SEND)
1 kHz -30 dB (316mV)	-60 dB ± 1 dB (1.12mV to 891mV)
1 kHz $+10$ dB (3.16V)	$+20$ dB ± 1 dB (8.91V to 11.2V)

2-3-4 ENCODE/DECODE (AUTO) SW "OFF" LEVEL CHECK

1. Apply a signal of 1 kHz -10 dB (0.3V) to the RCV jacks.
2. Place the ENCODE & DECODE (AUTO) SW in OFF position.
3. Check the -10 dB (0.3V) nominal level at the SEND jacks.

BLOCK DIAGRAM

BLOCK DIAGRAM

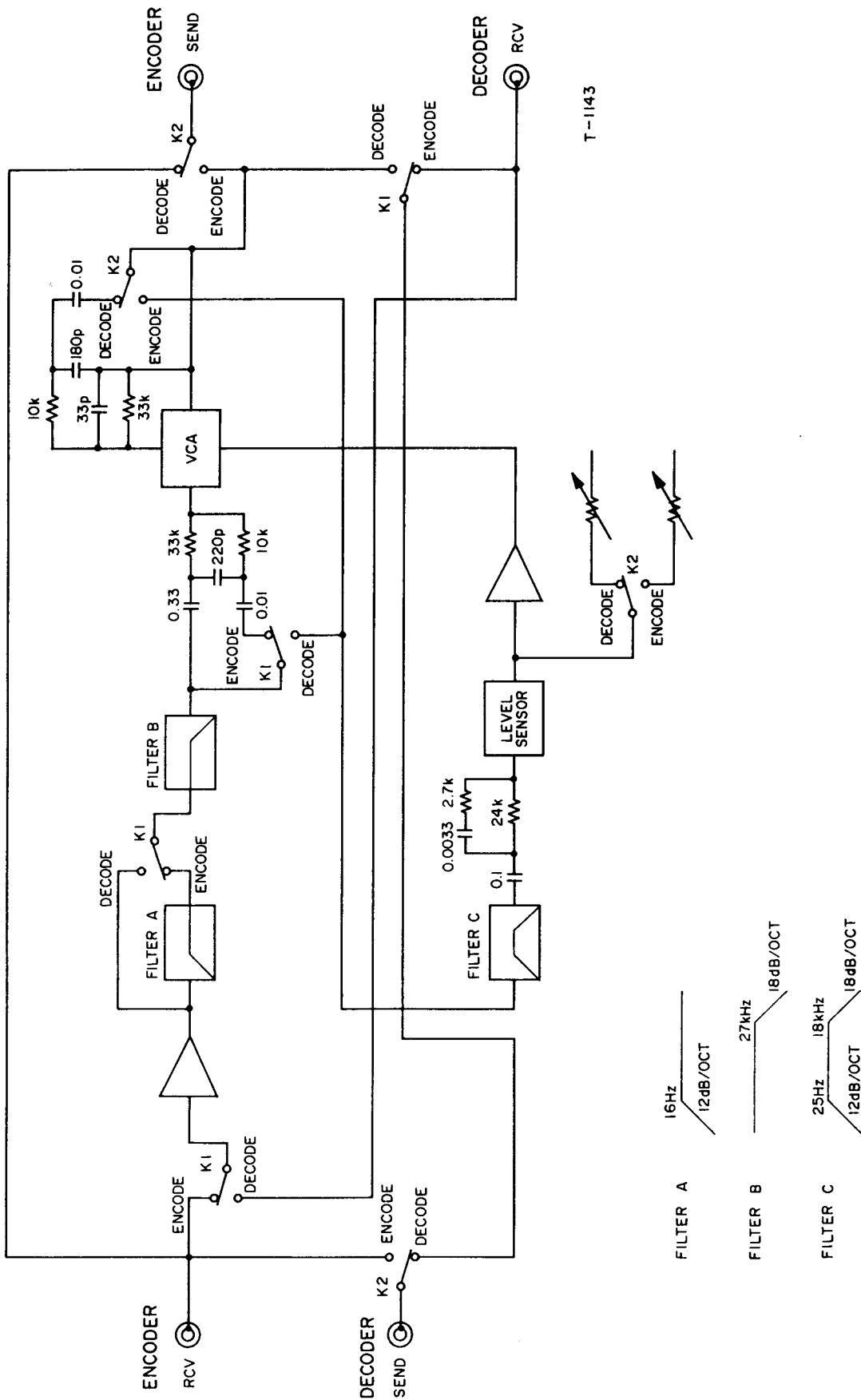

T-1143

PARTS LIST

— PARTS ORDERING INFORMATION —

Spare parts are available through your nearest TEAC Authorized Service Center or directly from the TEAC office, the address of which is printed on the back cover. When ordering parts, always include the following information:

- | | |
|--------------|--------------------|
| 1. MODEL | 4. DESCRIPTION |
| 2. REF. NO. | 5. UNIT SERIAL NO. |
| 3. PARTS NO. | 6. MANUAL CODE NO. |

NOTICE REGARDING PARTS ORDERS

1. Do not order by only REF. NO.
2. In some instances, individual minor parts are not available. In this case, the entire assembly, including the part requested, will be sent to you.
3. Parts are identical between different models with the exceptions as coded by the designations in the REMARKS column.
4. PC Boards shown viewed from component side.

———— TABLE OF CONTENTS ————

PARTS LOCATION AND PARTS LIST SECTION . . .	12~17
INCLUDED ACCESSORIES	13
PC BOARD SECTION	
1. POWER SUPPLY PCB	18, 19
2. DBX AMP PCB	20, 21
3. BUFFER AMP PCB	22
ASSEMBLING HARDWARE CODING LIST	23

PARTS LOCATION AND PARTS LIST SECTION

PARTS LOCATION-1

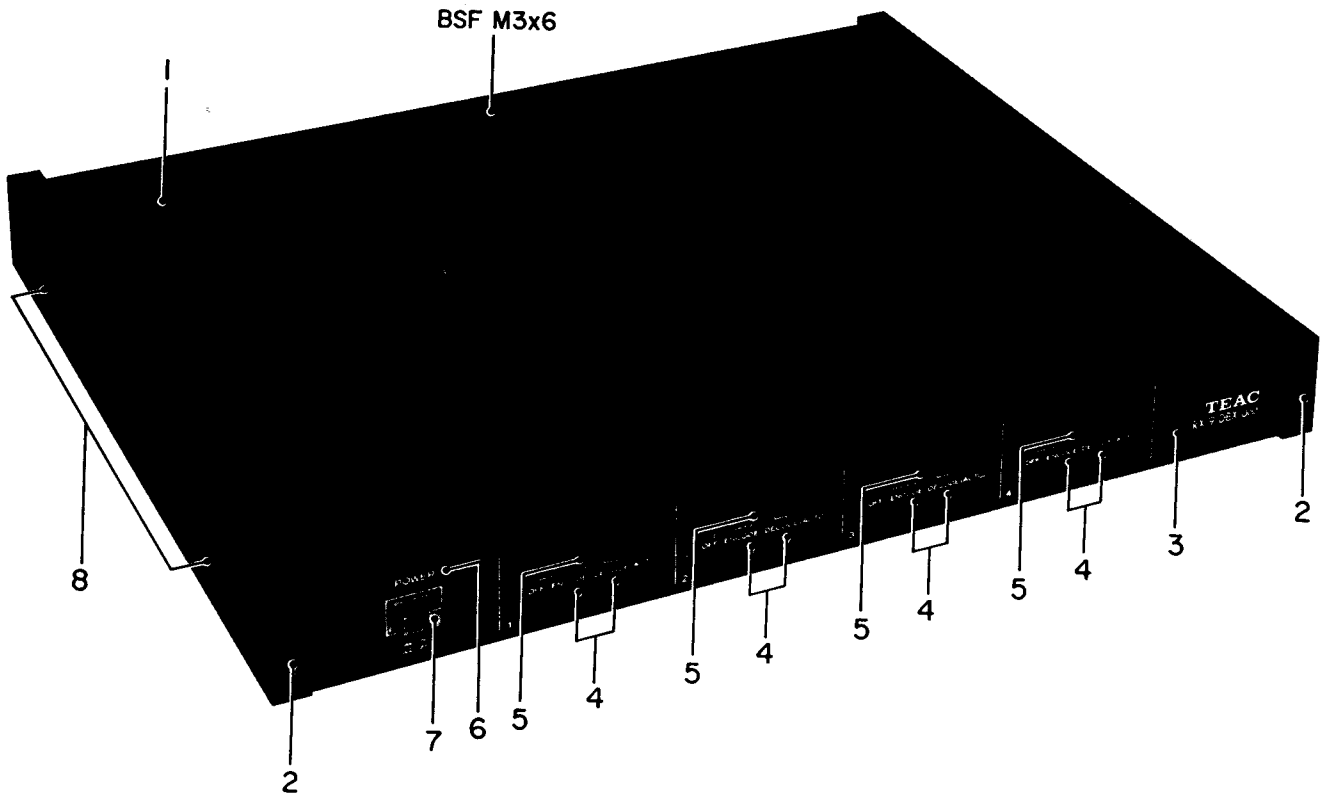

REF. NO.	PARTS NO.	DESCRIPTION	REMARKS
1 - 1	60375370	Cover, Top; B	All except JAPAN JAPAN
1 - 2	60375380	Board, Side	
1 - 3	60362593	Panel, Front; B	
	60362661	Panel, Front; D	
1 - 4	60362200	Lens, Lamp	
1 - 5	60516010	Switch, Slide	
1 - 6	60483330	LED (Green)	
1 - 7	55344310	Button, B	
1 - 8	55044110	Screw Assy, Side Board	
	55810430	Screw, Side Board	
	55342780	Washer, Side Board	Part of 1 - 8

INCLUDED ACCESSORIES

REF. NO.	PARTS NO.	DESCRIPTION	REMARKS
	50471250	Cord, Input-output Connection (8 used)	
	51015700	DX-34 Owner's Manual	JAPAN
	51015690	RX-9 Owner's Manual	U.S.A.
	51015710	RX-9 Owner's Manual	All except JAPAN, U.S.A.

PARTS LOCATION-2

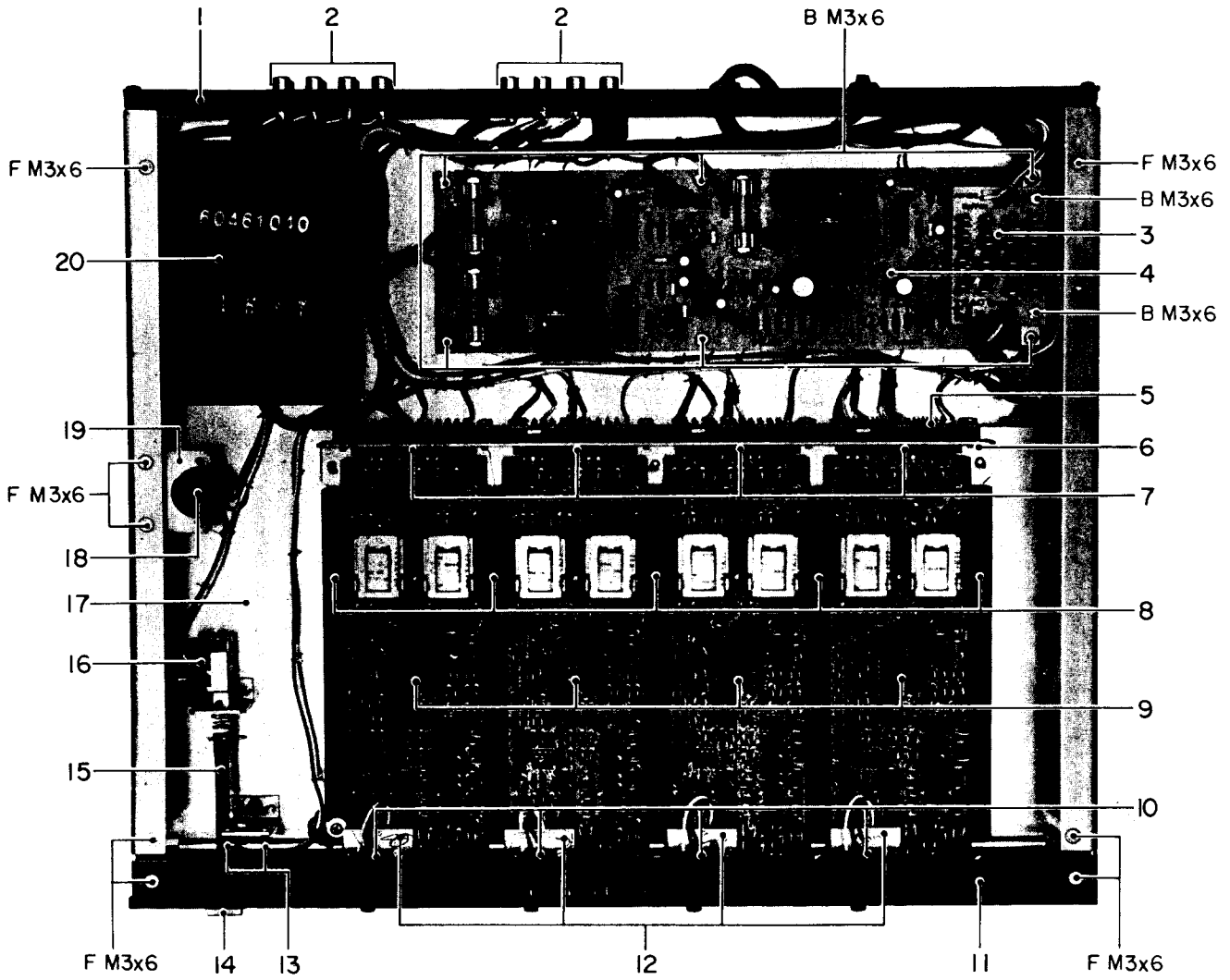

REF. NO.	PARTS NO.	DESCRIPTION	REMARKS
2 - 1	60362601	Panel, Rear, B	
2 - 2	60523410	Terminal Assy, 8P	
2 - 3	60854430	PCB Assy, BUFFER AMP	
	60505150	PCB, BUFFER AMP	
2 - 4	60854320-06	PCB Assy, POWER SUPPLY	JAPAN, GENERAL EXPORT
	60854320-05	PCB Assy, POWER SUPPLY	EUROPE, U.K., AUSTRALIA
	60854320-04	PCB Assy, POWER SUPPLY	U.S.A., CANADA
	60505013	PCB, POWER SUPPLY	
2 - 5	60854360	PCB Assy, CONNECTOR BOARD	
	60505021	PCB, CONNECTOR BOARD	
2 - 6	60375390	Bracket, Connector	
2 - 7	60523440	Connector, PCB	
2 - 8	60375330	Guide, PCB; B	
2 - 9	60854310-01	PCB Assy, dbx AMP	
	60505081	PCB, dbx AMP	
2 - 10	60516010	Switch, Slide	
2 - 11	60362593	Panel, Front; B	All except JAPAN
	60362661	Panel, Front; D	JAPAN
2 - 12	60375171	Plate, Switch	
2 - 13	55240431	Spring, LED	
2 - 14	55344310	Button, B	
2 - 15	55344221	Rod, Switch	
2 - 16	51340460	Switch, Power	U.S.A., CANADA, JAPAN
	51340110	Switch, Power	GENERAL EXPORT
			EUROPE, U.K., AUSTRALIA
2 - 17	60375362	Chassis, B	
2 - 18	50435060	Selector, Voltage	GENERAL EXPORT
2 - 19	60375350	Bracket, Voltage Selector	GENERAL EXPORT
2 - 20	60461011	Transformer, Power	JAPAN
	60461021	Transformer, Power	U.S.A., CANADA
	60461030	Transformer, Power	EUROPE, U.K., AUSTRALIA
	60461040	Transformer, Power	GENERAL EXPORT

PARTS LOCATION-3

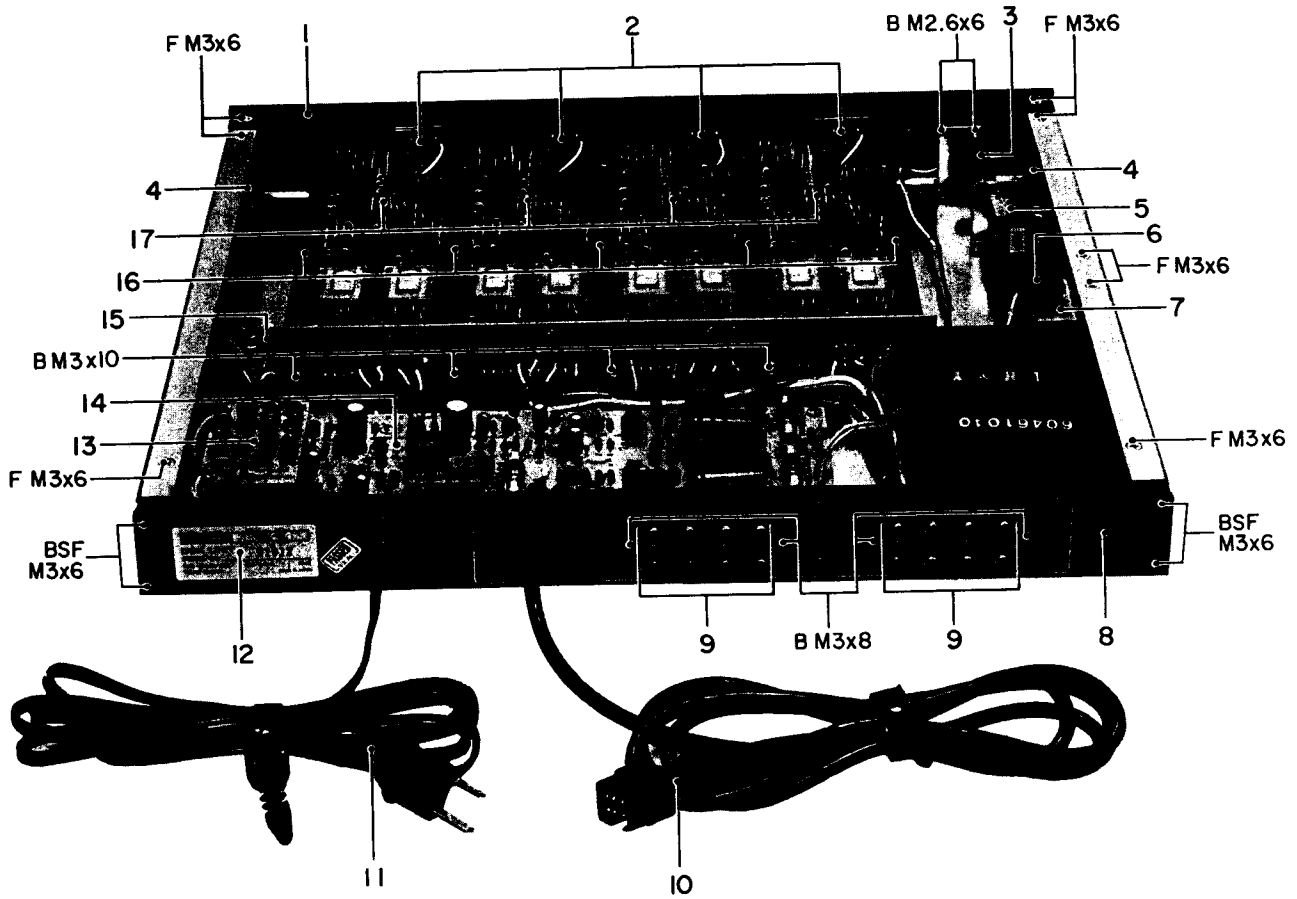

REF. NO.	PARTS NO.	DESCRIPTION	REMARKS
3 - 1	60362593	Panel, Front; B	All except, JAPAN JAPAN
	60362661	Panel, Front; D	
3 - 2	60516010	Switch, Slide	
3 - 3	55344221	Rod, Switch	
3 - 4	60030750	Stay	
3 - 5	51340460	Switch, Power	U.S.A., CANADA, JAPAN GENERAL EXPORT
	51340110	Switch, Power	EUROPE, U.K., AUSTRALIA
3 - 6	50435060	Selector, Voltage	GENERAL EXPORT
3 - 7	60375350	Bracket, Voltage Selector	GENERAL EXPORT
3 - 8	60362601	Panel, Rear; B	
3 - 9	60523410	Terminal Assy, 8P	
3 - 10	51280820	Cord, Connector; 6P	
3 - 11	51280340	Cord, AC Power	JAPAN, GENERAL EXPORT
	51280750	Cord, AC Power	U.S.A., CANADA
	60491250	Cord, AC Power	EUROPE
	51280470	Cord, AC Power	U.K.
	60491180	Cord, AC Power	AUSTRALIA
3 - 12	60072790	Plate, Name; 117V AC	
	60072800	Plate, Name; 220V AC	
	60072810	Plate, Name; 240V AC	
	60072820	Plate, Name; 100~240V AC	
	60072830	Plate, Name; 100V AC	
	60072840	Plate, Name; 240V AC	
3 - 13	60854430	PCB Assy, BUFFER AMP	
	60505150	PCB, BUFFER AMP	
3 - 14	60854320-06	PCB Assy, POWER SUPPLY	JAPAN, GENERAL EXPORT
	60854320-05	PCB Assy, POWER SUPPLY	EUROPE, U.K., AUSTRALIA
	60854320-04	PCB Assy, POWER SUPPLY	U.S.A., CANADA
	60505013	PCB, POWER SUPPLY	
3 - 15	60854360	PCB Assy, CONNECTOR BOARD	
	60505021	PCB, CONNECTOR BOARD	
3 - 16	60375330	Guide, PCB; B	
3 - 17	60854310-01	PCB Assy, dbx AMP	
	60505081	PCB, dbx AMP	

PC BOARD SECTION (Diagram)

1. POWER SUPPLY PCB

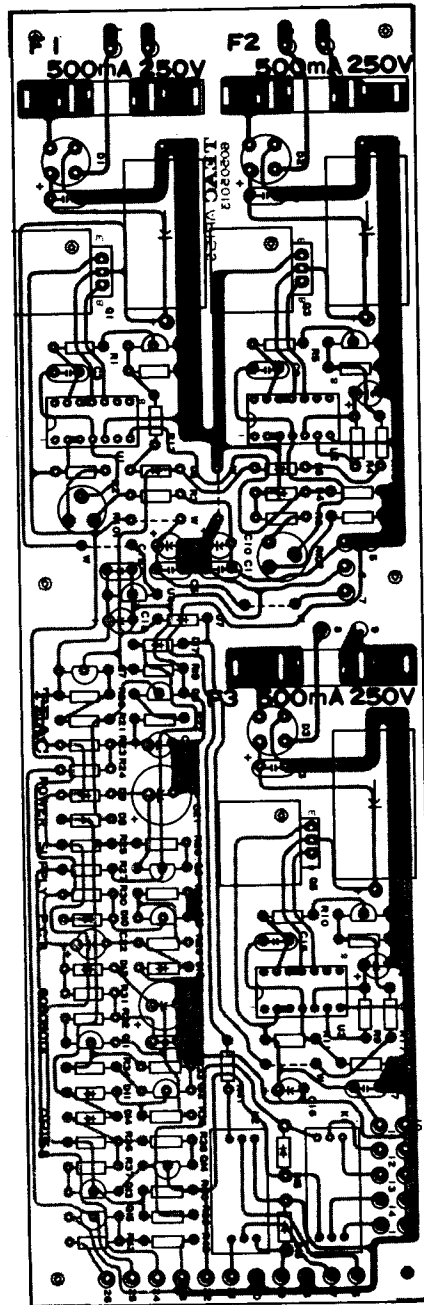

REF. NO.	PARTS NO.	DESCRIPTION
	60854320-03	PCB Assy, POWER SUPPLY (JAPAN, GENERAL EXPORT)
	60854320-02	PCB Assy, POWER SUPPLY (AUSTRALIA, EUROPE, U.K.)
	60854320-01	PCB Assy, POWER SUPPLY (U.S.A., CANADA)
	60505013	PCB, POWER SUPPLY
	IC's	
U1~U3	60486060	μ A723PC
U4	60486370	NJM78L15

TRANSISTORS

Q1	60480560	2SD361-D
Q2	60480850	2SC711A-F
Q3	60480560	2SD361-D
Q4	60480850	2SC711A-F
Q5	60480560	2SC711A-F
Q6	60480850	2SA725-F
Q7	60480520	2SA725-F
Q8	60480850	2SC711A-F
Q9	60480520	2SA725-F
Q11	60480520	2SA725-F
Q12	60480850	2SC711A-F

DIODES

D1~D3	60487310	Stack, W-02M
D4	60483390	Zener, RD-6AN
D5	50425500	1S2473
D6	60483230	Zener, RD-19A
D7	50425500	1S2473
D9	50425500	1S2473
D11, D12	50425500	1S2473
D17	50425500	1S2473

CARBON RESISTORS

All resistors are rated $\pm 5\%$ tolerance and $\frac{1}{4}$ watt.

R1	2.2 k ohm
R2, R3	10 k ohm
R4	3.3 k ohm
R5	2.2 k ohm
R6, R7	3.3 k ohm
R8	2.2 k ohm
R9	3.3 k ohm
R10	2.2 k ohm
R11	5.6 k ohm
R12	8.2 k ohm
R13	22 k ohm
R14	10 k ohm
R15	22 k ohm
R16	10 k ohm
R17	22 k ohm
R18	10 k ohm

REF. NO.	PARTS NO.	DESCRIPTION
R19		47 k ohm
R20		2.2 k ohm
R21		22 k ohm
R22		1 k ohm
R23		120 k ohm
R24		1 k ohm
R25, R26		27 k ohm
R31		47 k ohm
R32		22 k ohm
R33, R34		47 k ohm
R35		12 k ohm
R40		820 ohm
R41		1 k ohm

CAPACITORS

C1	50555150	Elec.	470 mfd	35V
C2	60440050	Ceramic	0.01 mfd	
C3	60435540	Polyst.	100 pfd	
C4	50554040	Elec.	10 mfd	25V
C5	60440050	Ceramic	0.01 mfd	
C6	50555150	Elec.	470 mfd	35V
C7	60440050	Ceramic	0.01 mfd	
C8	50554670	Elec.	1 mfd	25V
C9	60435540	Polyst.	100 pfd	
C10	50554040	Elec.	10 mfd	25V
C11	60440050	Ceramic	0.01 mfd	
C12	50555150	Elec.	470 mfd	35V
C13	60440050	Ceramic	0.01 mfd	
C14	50554670	Elec.	1 mfd	25V
C15	60435540	Polyst.	100 pfd	
C16	50554040	Elec.	10 mfd	25V
C17	60440050	Ceramic	0.01 mfd	
C18	50554040	Elec.	10 mfd	25V
C19	60440050	Ceramic	0.01 mfd	
C20	50554670	Elec.	1 mfd	25V
C21	50554400	Elec.	470 mfd	16V
C23	50554390	Elec.	220 mfd	16V
C24	60440050	Ceramic	0.01 mfd	

VARIABLE RESISTORS

R101, R102	50533400	Semi-fixed, 1 k ohm
------------	----------	---------------------

MISCELLANEOUS

60450240	Heat Sink (3 used)
50412370	Holder, Fuse (6 used) (JAPAN, GENERAL EXPORT, U.S.A., CANADA)
51420870	Holder, Fuse (6 used) (EUROPE, U.K., AUSTRALIA)
50411460	Fuse, 500mA 250V (U.S.A., CANADA)
50411540	Fuse, 500mA 250V (EUROPE, U.K., AUSTRALIA)
50411130	Fuse, 500mA 250V (JAPAN, GENERAL EXPORT)

REF. NO.	PARTS NO.	DESCRIPTION
----------	-----------	-------------

	60854310-01	PCB Assy, dbx AMP
--	-------------	-------------------

	6050581	PCB, dbx AMP
--	---------	--------------

IC's

IC1~IC4	60486070	NJM4558D-F
IC5	51470200	BA-651
IC6	51470210	BA-652

TRANSISTORS

Q1	50424780	FET, 2SK34-B
Q2	60480760	2SC1312S-G
Q3	60480770	2SA725S-G
Q4	50424780	FET, 2SK34-B
Q5	60480760	2SC1312S-G
Q6	60480770	2SA725S-G
Q7, Q8	60480850	2SC711A-F
Q9	60480520	2SA725-F
Q10	60480850	2SC711A-F
Q11	60480520	2SA725-F
Q12~Q14	60480850	2SC711A-F
Q15	60480080	2SC1211-D
Q16	60480850	2SC711A-F
Q17	60480080	2SC1211-D

DIODES

D1~D11	60483370	1S2473VE
--------	----------	----------

RESISTORS

All resistors are rated $\pm 5\%$ tolerance, $\frac{1}{4}$ watt and of carbon type unless otherwise noted.

R1	390 k ohm
R2	820 k ohm
R3	47 k ohm
R4	100 k ohm
R5~R7	8.2 k ohm
R8	47 k ohm
R9	33 k ohm Metal Film
R10	10 k ohm Metal Film
R11	39 ohm
R12	10 k ohm
R13	39 ohm
R14	22 k ohm
R15	220 ohm
R16	3.3 k ohm
R17, R18	390 ohm
R19	1 k ohm
R20	10 k ohm
R21~R24	82 ohm Metal Film
R25	220 k ohm
R26	1 k ohm
R27	10 k ohm Metal Film
R28	33 k ohm Metal Film
R29	47 k ohm
R30	680 ohm
R31, R32	100 ohm
R33, R34	10 k ohm
R35	47 k ohm
R36	100 k ohm
R37	240 k ohm
R38	510 k ohm

REF. NO.	PARTS NO.	DESCRIPTION
----------	-----------	-------------

R39~R41	12 k ohm
R42	24 k ohm Metal Film
R43	2.7 k ohm Metal Film
R44	22 k ohm
R45	220 ohm
R46	3.3 k ohm
R47	390 ohm
R48	180 ohm
R49	390 ohm
R50	6.8 k ohm
R51	10 k ohm
R52	47 k ohm
R53	10 k ohm Metal Film
R54	270 k ohm
R55	1 k ohm
R56	2.2 M ohm
R57	20 k ohm Metal Film
R58	2.2 k ohm
R59	4.7 ohm
R60	1 M ohm 2%
R61	100 k ohm
R63	820 k ohm
R64	3.9 k ohm Metal Film
R65, R66	4.7 k ohm Metal Film
R67	1.2 k ohm
R70	1 M ohm 2%
R71	22 k ohm
R72	27 k ohm
R93	3.3 k ohm

CAPACITORS

C1, C2	60445450	Mylar	0.018 mfd	50V
C3	60431710	Dip. Tant.	2.2 mfd	16V
C4	60445220	Mylar	0.001 mfd	50V
C5	60445270	Mylar	0.0027 mfd	50V
C6	60435710	Polyst.	150 pfd	50V
C7	60431710	Dip. Tant.	2.2 mfd	16V
C8	60447700	Film	0.33 mfd	50V
C9	60445430	Mylar	0.01 mfd	50V
C11	60445220	Mylar	0.001 mfd	50V
C12	60435560	Polyst.	33 pfd	50V
C13	60435570	Polyst.	180 pfd	50V
C15~C17	60431750	Dip. Tant.	10 mfd	10V
C18, C19	60445450	Mylar	0.018 mfd	50V
C20	60445220	Mylar	0.001 mfd	50V
C21	60445270	Mylar	0.0027 mfd	50V
C22	60435710	Polyst.	150 pfd	50V
C23	60445620	Mylar	0.1 mfd	50V
C24	60445280	Mylar	0.0033 mfd	50V
C25	60435550	Polyst.	220 pfd	50V
C26	50546780	Dip. Tant.	22 mfd	16V
C32, C33	60432090	Dip. Tant.	4.7 mfd	25V
C34~C37	60440050	Ceramic	0.01 mfd	50V

VARIABLE RESISTORS

R101	60410120-12	Semi-fixed, 10 k ohm - B
R102, R103	60410120-16	Semi-fixed, 47 k ohm - B
R104	60410120-12	Semi-fixed, 10 k ohm - B
R105	60410120-16	Semi-fixed, 47 k ohm - B

MISCELLANEOUS

60521790	Socket, IC; 14P (2 used)
----------	--------------------------

3. BUFFER AMP

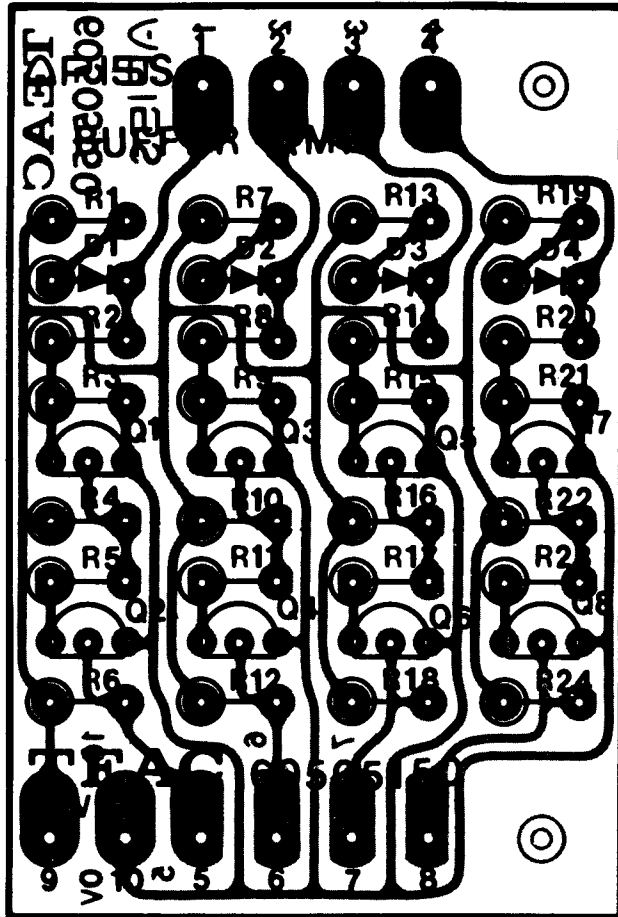

REF. NO.	PARTS NO.	DESCRIPTION
	60854430	PCB Assy, BUFFER AMP
	60505150	PCB, BUFFER AMP
TRANSISTORS		
Q1~Q8	60480850	2SC711A-F
DIODES		
D1~D4	60483370	1S2473VE
CARBON RESISTORS		
All resistors are rated $\pm 5\%$ tolerance and $\frac{1}{4}$ watt.		
R1		100 k ohm
R2		47 k ohm
R3		12 k ohm
R4		22 k ohm
R5		12 k ohm

REF. NO.	PARTS NO.	DESCRIPTION
R6		22 k ohm
R7		100 k ohm
R8		47 k ohm
R9		12 k ohm
R10		22 k ohm
R11		12 k ohm
R12		22 k ohm
R13		100 k ohm
R14		47 k ohm
R15		12 k ohm
R16		22 k ohm
R17		12 k ohm
R18		22 k ohm
R19		100 k ohm
R20		47 k ohm
R21		12 k ohm
R22		22 k ohm
R23		12 k ohm
R24		22 k ohm

ASSEMBLING HARDWARE CODING LIST

All screws conform to ISO standards, and have crossrecessed heads, unless otherwise noted. ISO screws have the head inscribed with a point as in the figure to the right.



FOR EXAMPLE:

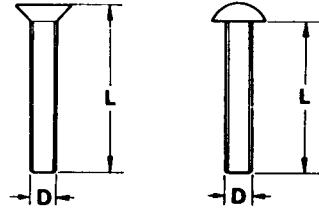
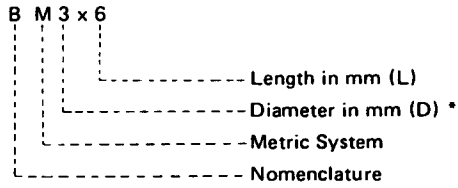

* Inner dia. for washers and nuts

	Code	Name	Type		Code	Name	Type
MACHINE SCREW	R	Round Head Screw		TAPPING SCREW	BTA	Binding Head Tapping Screw(A Type)	
	P	Pan Head Screw			BTB	Binding Head Tapping Screw(B Type)	
	T	Stove Head Screw (Truss)			RTA	Round Head Tapping Screw(A Type)	
	B	Binding Head Screw			RTB	Round Head Tapping Screw(B Type)	
	F	Flat Countersunk Head Screw		SETSCREW	SF	Hex Socket Setscrew(Flat Point)	
	O	Oval Countersunk Head Screw			SC	Hex Socket Setscrew(Cup Point)	
WOOD SCREW	RW	Round Head Wood Screw			SS	Slotted Socket Setscrew(Flat Point)	
	FW	Flat Countersunk Wood Screw		WASHER	E	E-Ring (Retaining Washer)	
	OW	Oval Countersunk Wood Screw			W	Flat Washer (Plain)	
SEMS SCREW	BSA	Binding Head SEMS Screw(A Type)			SW	Lock Washer (Spring)	
	BSB	Binding Head SEMS Screw(B Type)			LWI	Lock Washer (Internal Teeth)	
	BSF	Binding Head SEMS Screw(F Type)			LWE	Lock Washer (External Teeth)	
	PSA	Pan Head SEMS Screw(A Type)		TW	Trim Washer (Countersunk)		
	PSB	Pan Head SEMS Screw(B Type)		NUT	N	Hex Nut	