

**SCHEMATIC DIAGRAM - TUNER SECTION -** • See page 18 for Note.

1      2      3      4      5      6      7      8      9

	Germany	AEP,UK,E
R3	330	
R4	330	33
R5	330	33

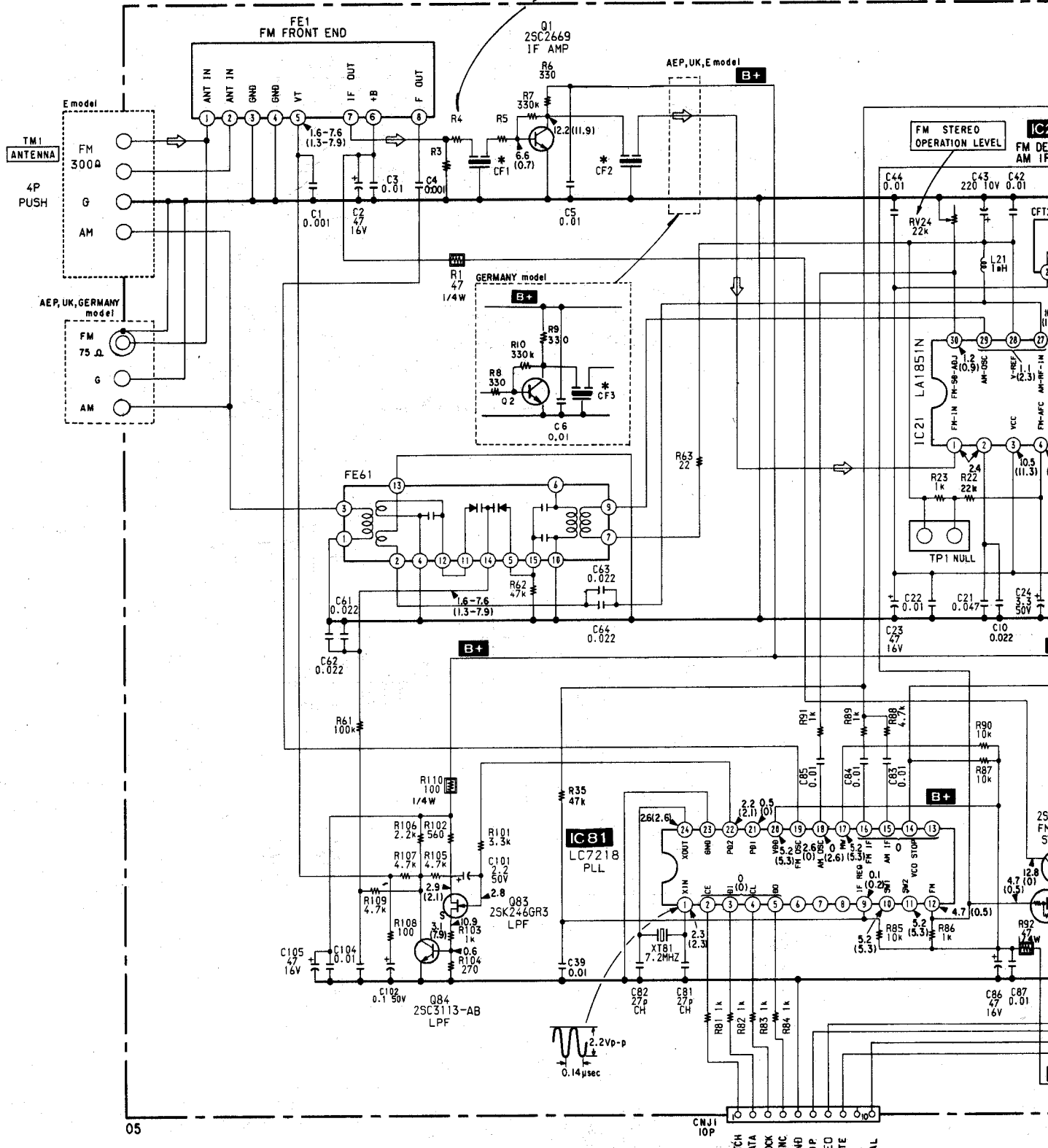

05

CN11 IOP  
LATCH DATA CLOCK MC GND  
AUTO STOP STEREO MUTE H/L  
TUNER MUTE H/L  
SIGNAL

Germany	AEP.UK.E
330	
330	33
330	33

**[TUNER BOARD]**

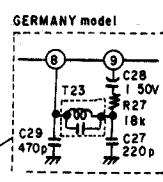
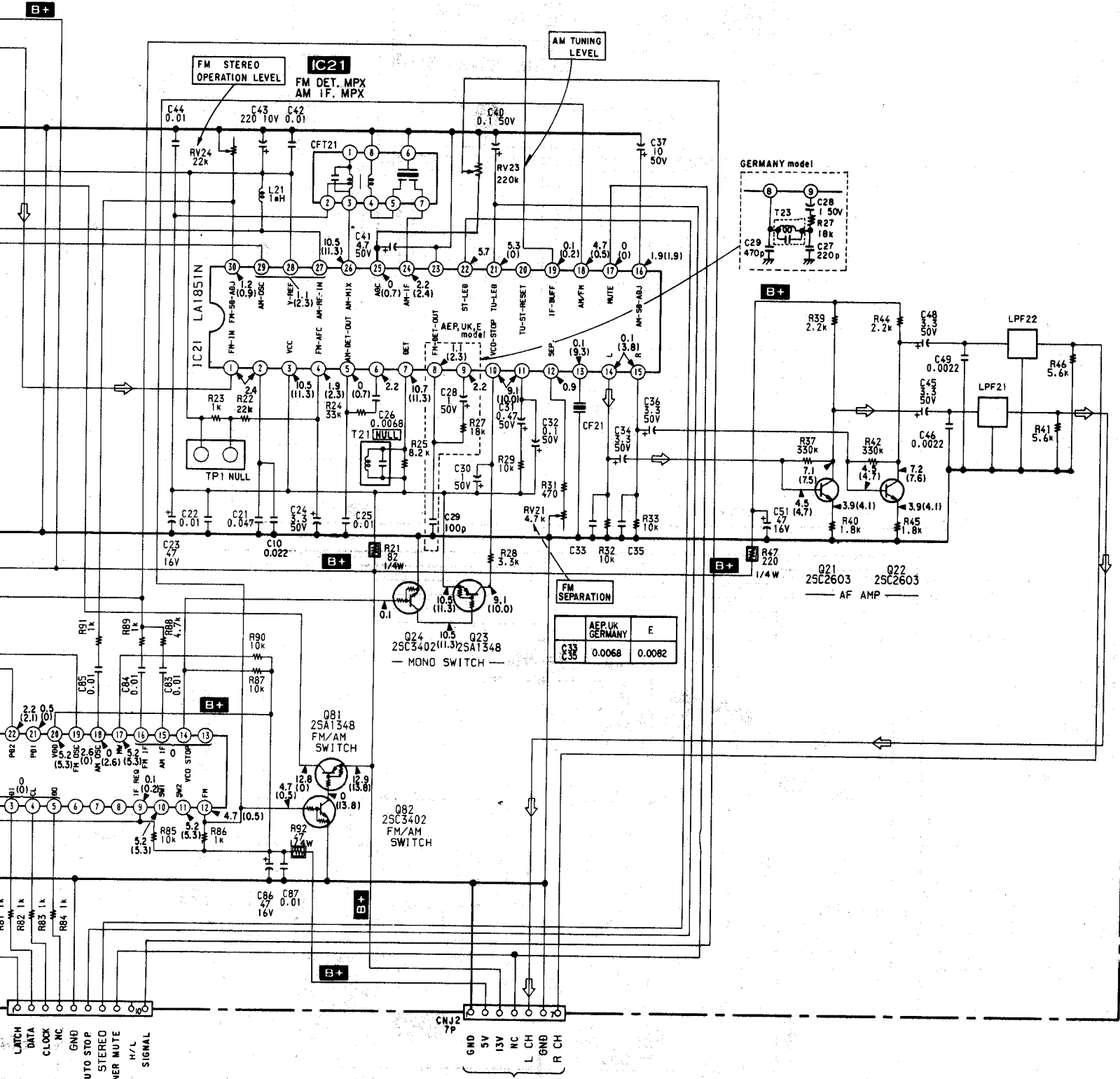

FM SEPARATION

AEP.UK	E
C33	0.0068
C32	0.0082

Q24 10.5 25C3402(11.3)2SA1348  
Q23 9.1 25A1348  
— MOND SWITCH —

Q81 2SA1348  
FM/AM SWITCH

Q82 25C3402  
FM/AM SWITCH

- LATCH
- DATA
- CLOCK
- NC
- GND
- AUTO STOP
- STEREO
- MUTE
- TUNER
- H/L
- SIGNAL

- 5V
- 13V
- NC
- CH
- GND
- R
- L

**A**

**B**

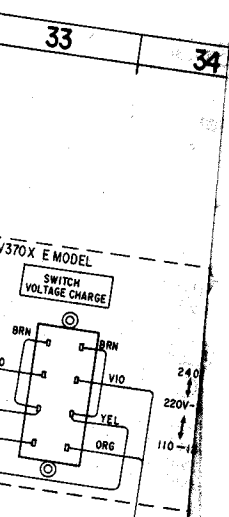

E  
F  
G  
H  
I  
J  
K  
L  
M  
N  
O  
P

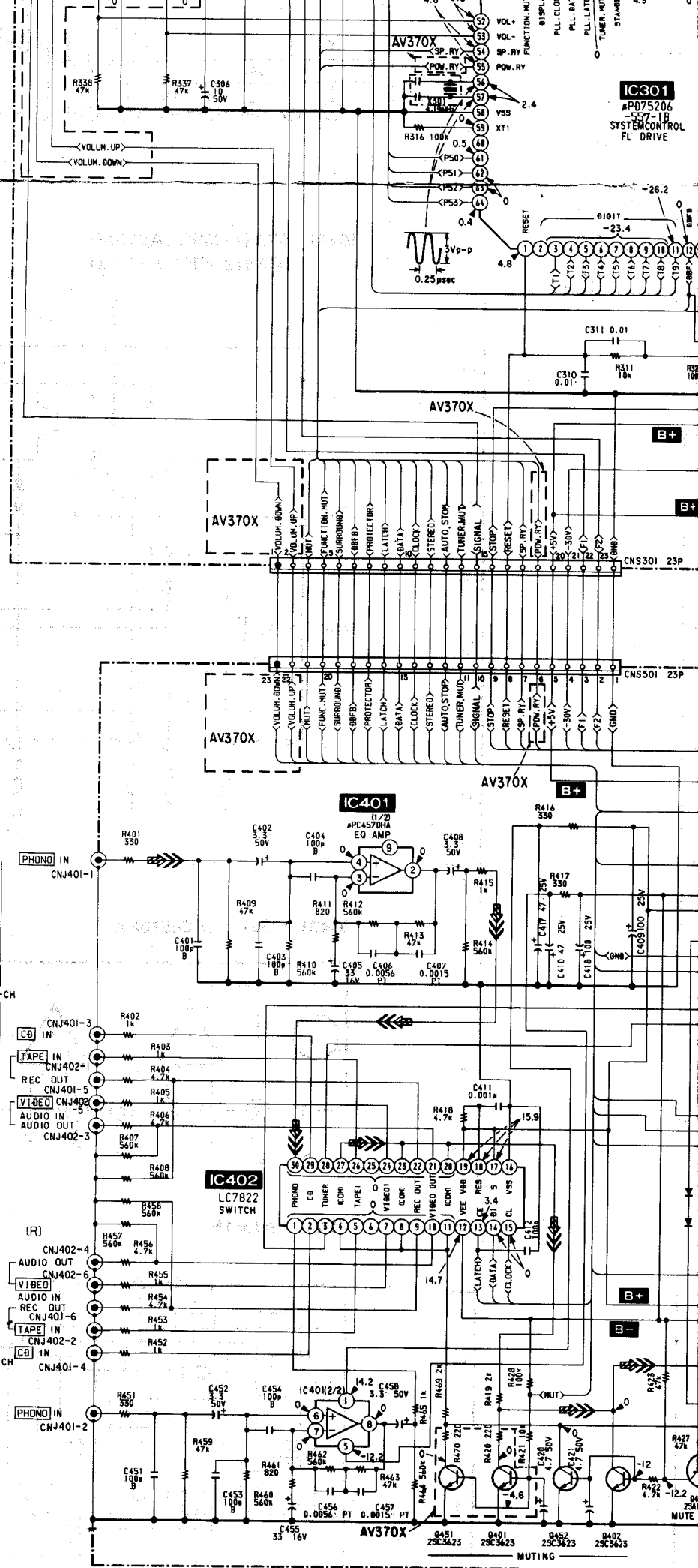

**IC301**  
APD75206  
557-1B  
SYSTEM CONTROL  
FL DRIVE

**IC401**  
APC4570HA  
EQ AMP

**IC402**  
LC7822  
SWITCH

**AV370X**  
MUTING

**B+**

**B-**

**B+**

**B-**

**B+**

**B-**

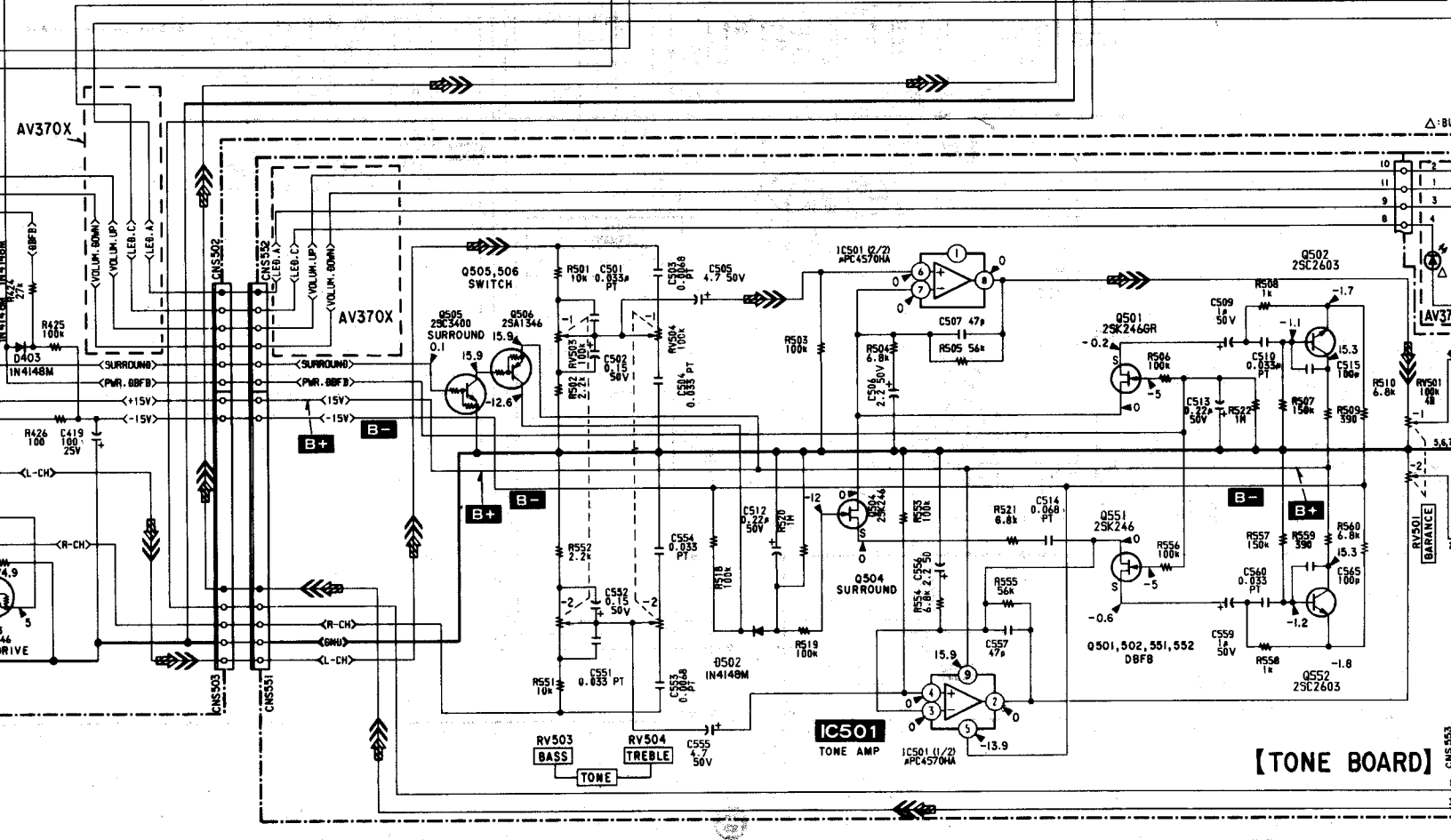
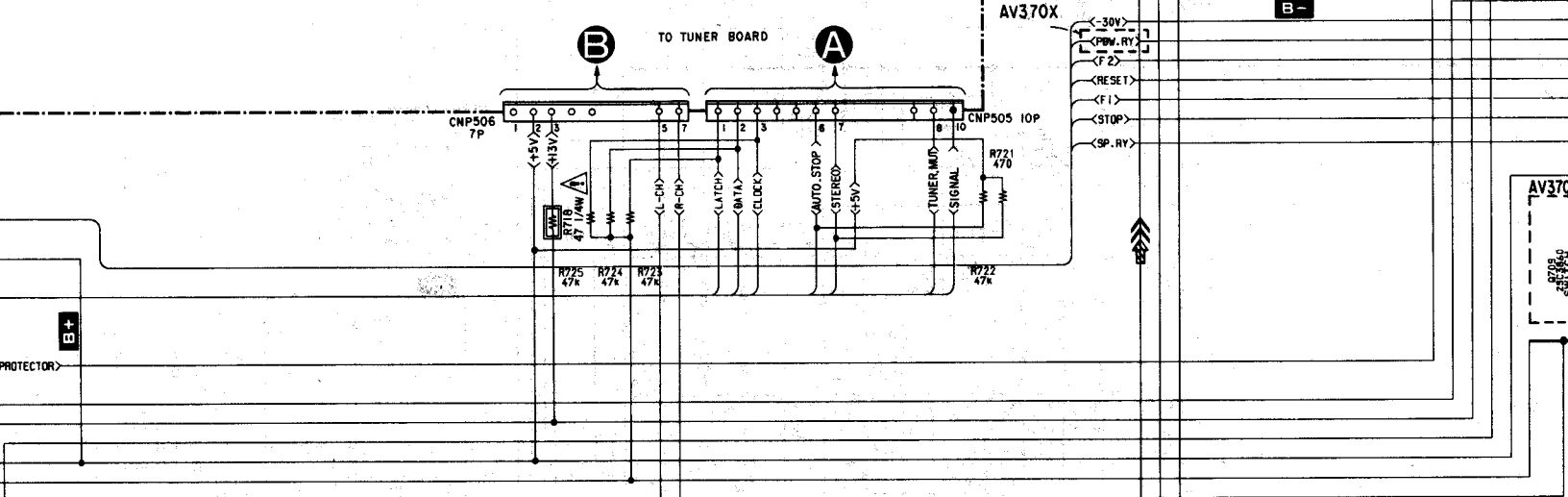
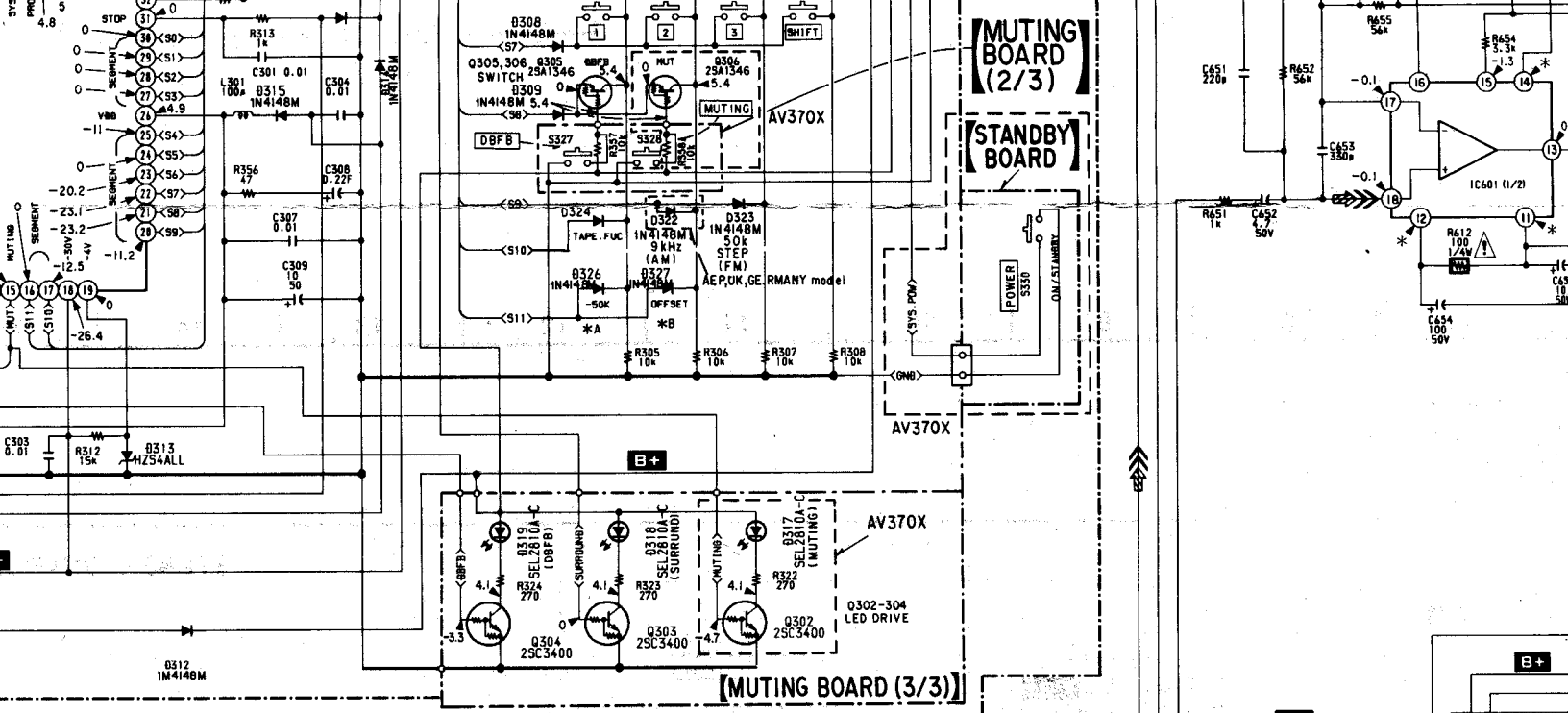

A  
B  
C  
D  
E  
F  
G  
H  
I  
J  
K  
L

[DISPLAY BOARD] FL301 FLUORESCENT INDICATOR TUBE

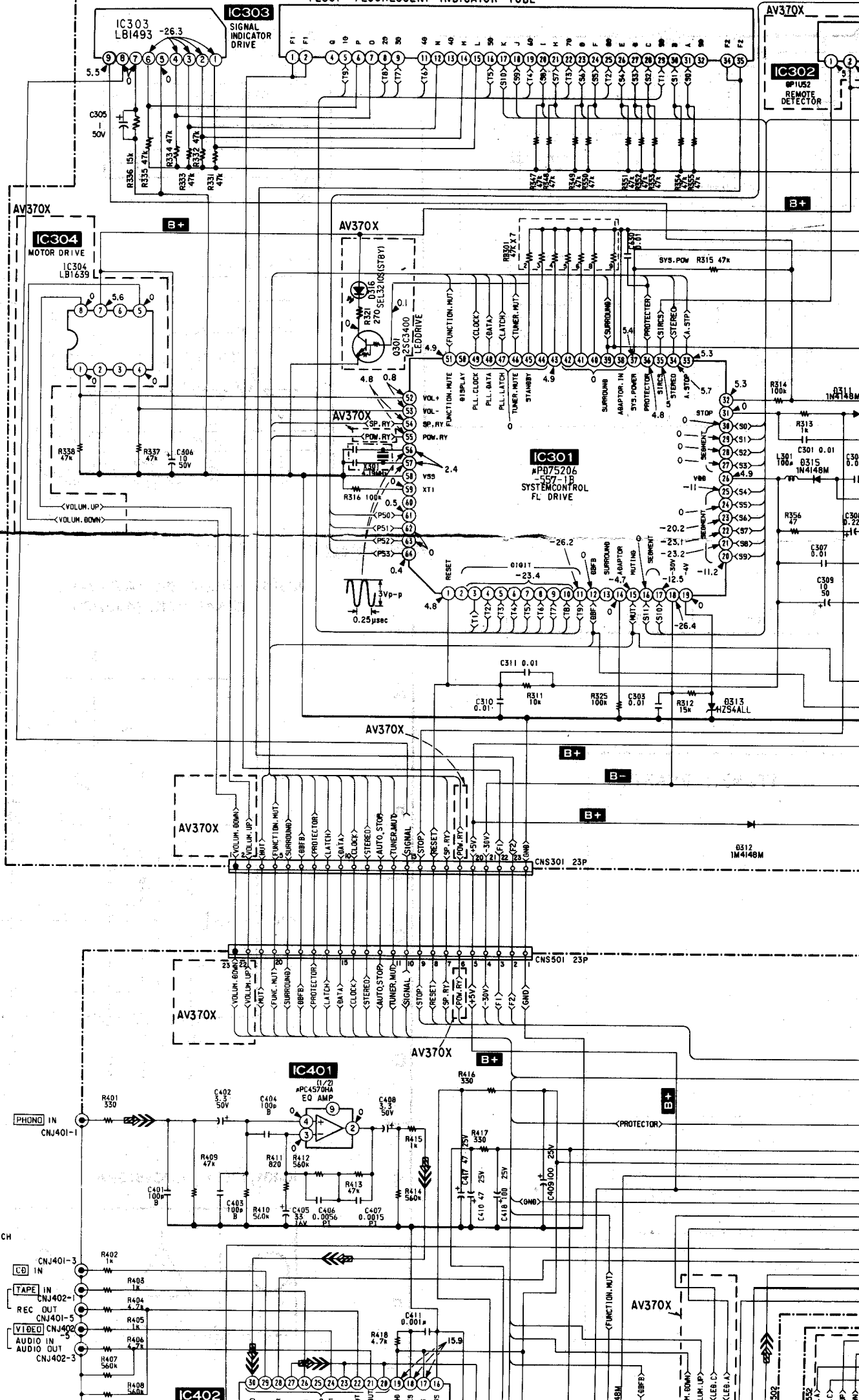

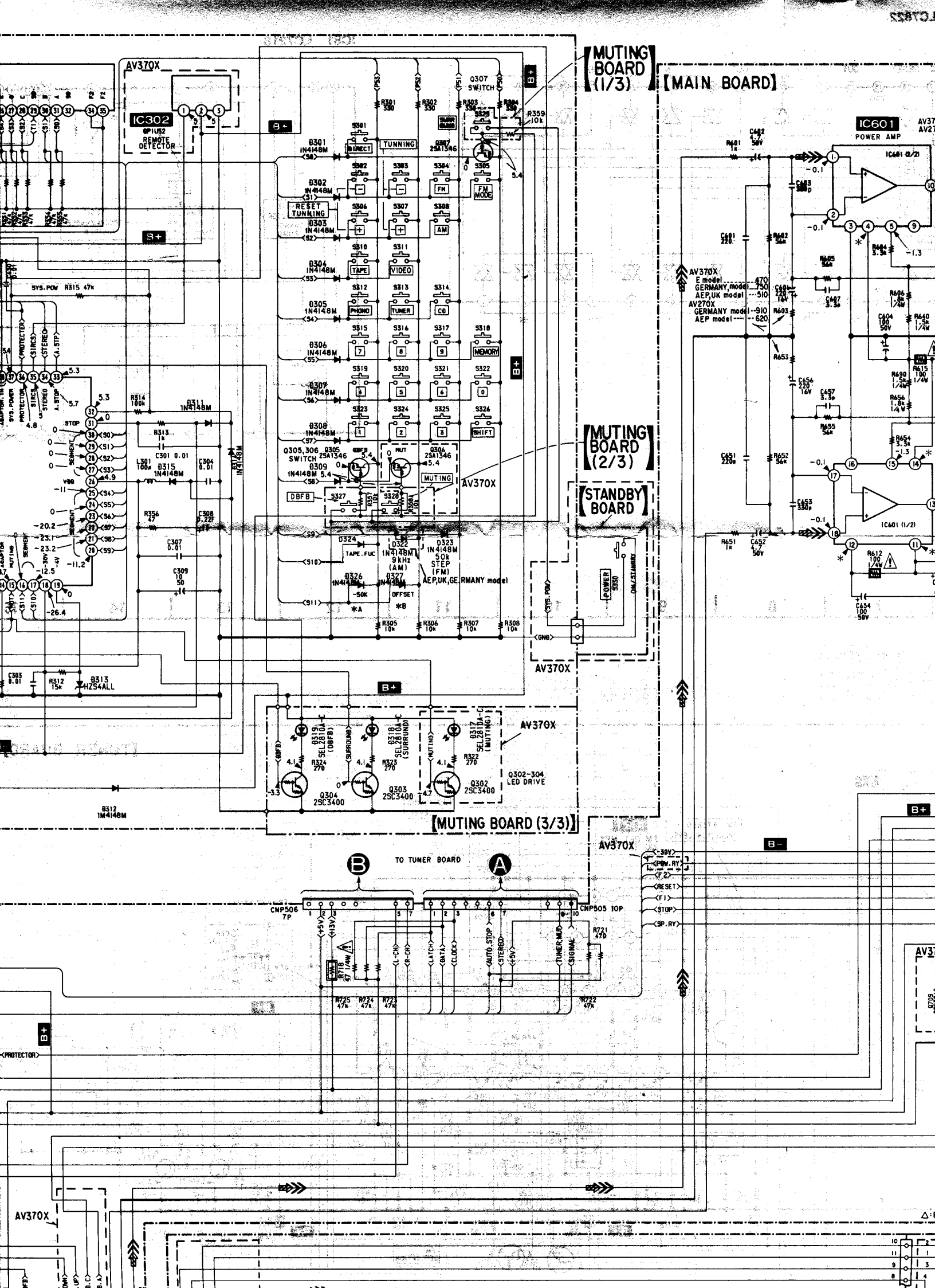

**MUTING BOARD (1/3)**

**[MAIN BOARD]**

**MUTING BOARD (2/3)**

**[STANDBY BOARD]**

**[MUTING BOARD (3/3)]**

**IC601 POWER AMP**

**AV370X**

**IC302 REMOTE DETECTOR**

**TUNING**

**RESET TUNNING**

**TAPE VIDEO**

**PHONE TUNER CB**

**MEMORY**

**SHIFT**

**MUTING**

**DBFB**

**TAPE FUC**

**Q303, Q304, Q305, Q306, Q307, Q308, Q309**

**Q302 LED DRIVE**

**TO TUNER BOARD**

**IC601 12/20**

**IC601 (1/2)**

**IC601 (1/1)**

**IC601 (1/2)**

**IC601 (1/2)**

**IC601 (1/2)**

**IC601 (1/2)**

**IC601 (1/2)**

**IC601 (1/2)**

**IC601 (1/2)**

**IC601 (1/2)**

**IC601 (1/2)**

**IC601 (1/2)**

**IC601 (1/2)**

**IC601 (1/2)**

**IC601 (1/2)**

**IC601 (1/2)**

**IC601 (1/2)**

**IC601 (1/2)**

**IC601 (1/2)**

**IC601 (1/2)**

**IC601 (1/2)**

**IC601 (1/2)**

**IC601 (1/2)**

**IC601 (1/2)**

**IC601 (1/2)**

**IC601 (1/2)**

**IC601 (1/2)**

**IC601 (1/2)**

**IC601 (1/2)**

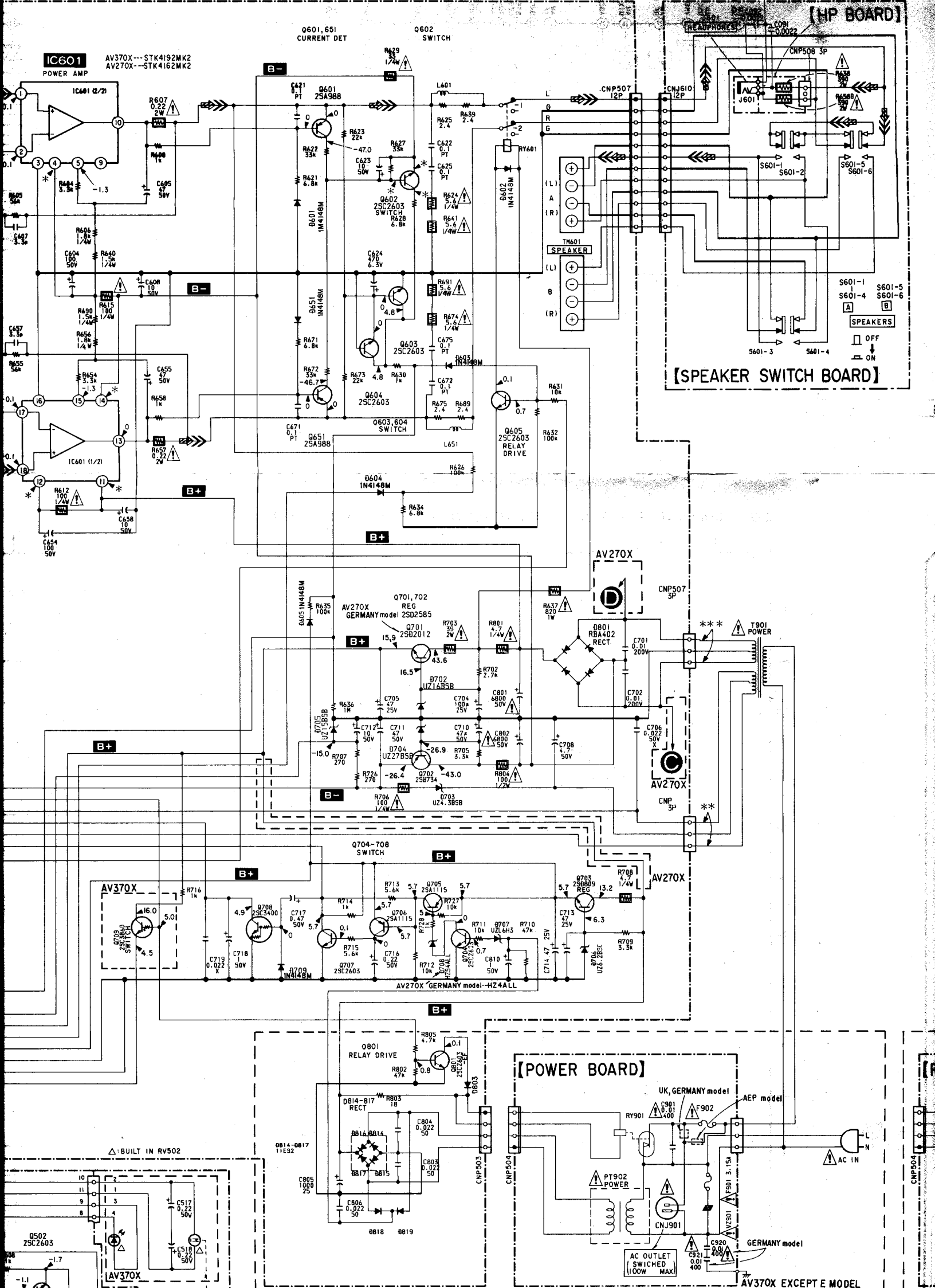

**IC601**  
POWER AMP

AV370X---STK4192MK2  
AV270X---STK4162MK2

**Q601, 651**  
CURRENT DET

**Q602**  
SWITCH

**[HP BOARD]**

**[SPEAKER SWITCH BOARD]**

**AV270X**

**AV270X**

**[POWER BOARD]**

UK, GERMANY model  
AEP model

GERMANY model  
AV370X EXCEPT E MODEL

△ BUILT IN RV502

Q502  
ZSC2603

AV370X

S601-1 S601-5  
S601-4 S601-6  
SPEAKERS  
OFF ON

AV270X

AV270X

AC OUTLET  
(SWITCHED  
1100W MAX)

AV370X EXCEPT E MODEL

[SPEAKER SWITCH BOARD]

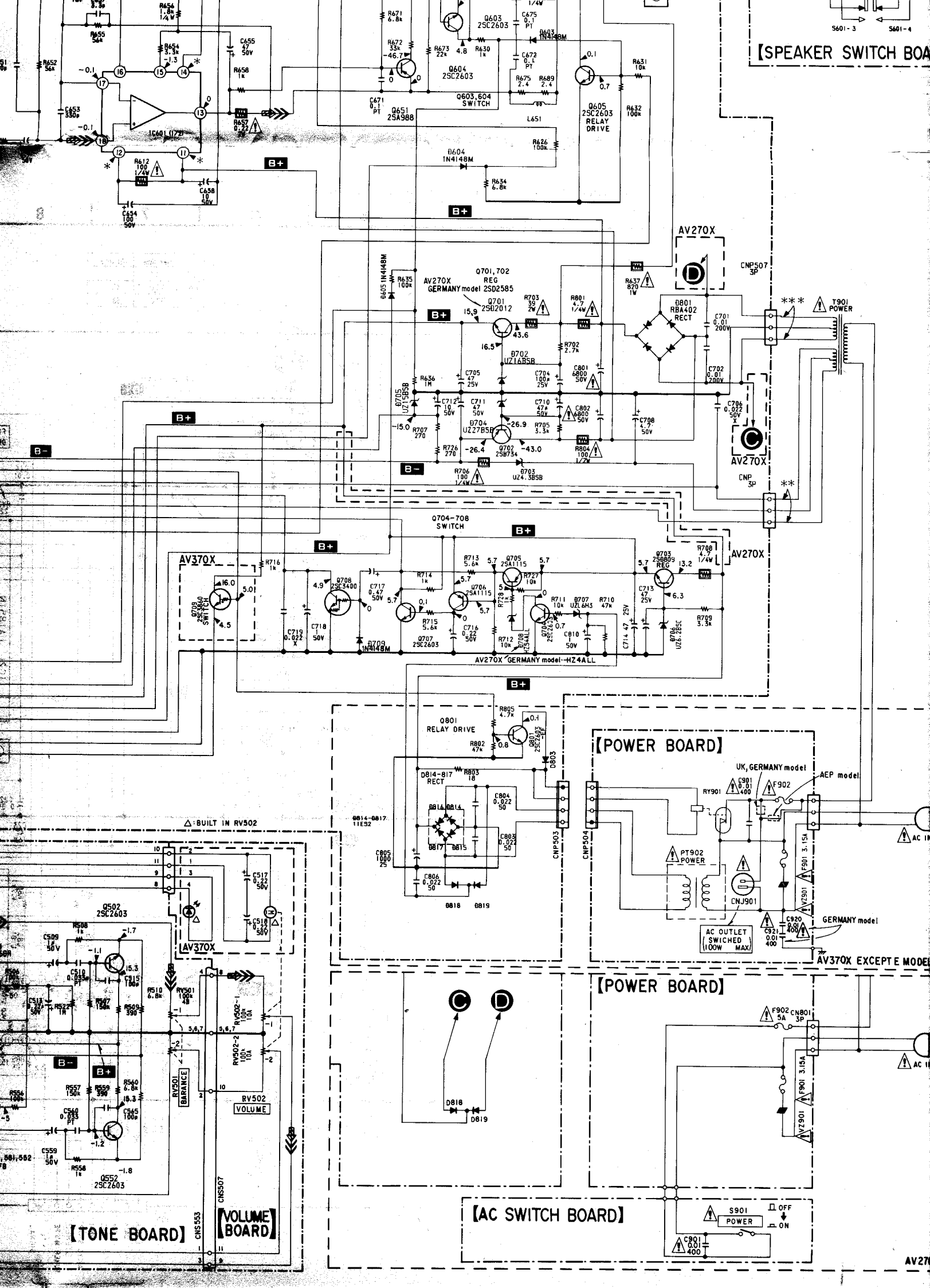

S601-3 S601-4

AV270X

AV270X

AV270X

AV370X

AV270X

[POWER BOARD]

[POWER BOARD]

[AC SWITCH BOARD]

[TONE BOARD]

[VOLUME BOARD]

△: BUILT IN RV502

AV370X EXCEPT E MODEL