

MODEL Radiola II  
 MODEL Radiola III  
 MODEL Radiola

R. C. A. VICTOR CO., INC.

Balanced Amp.

MODEL Radiola Sen. Amp.

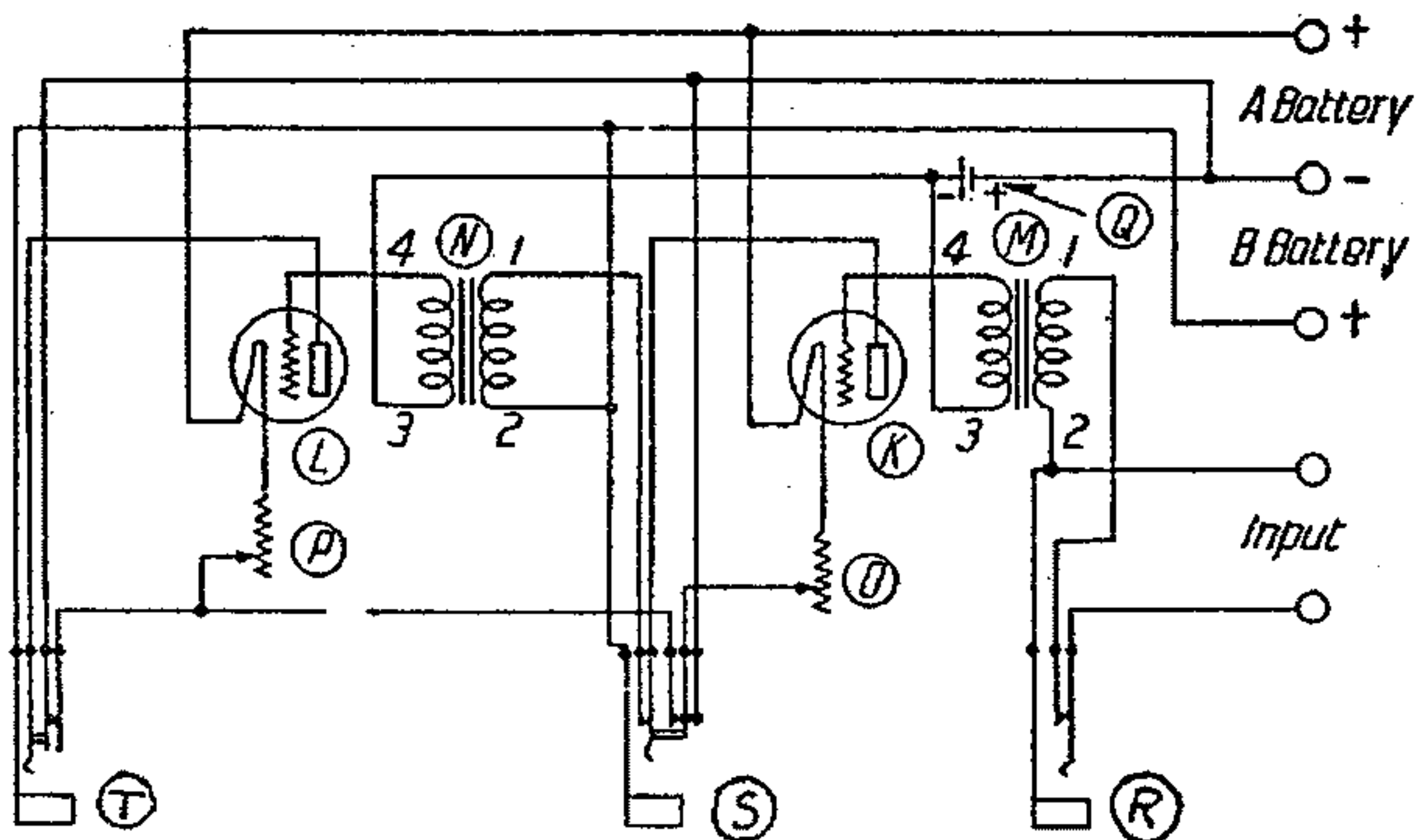

Model Senior Amp.

Model Radiola Senior Amplifier (1922)

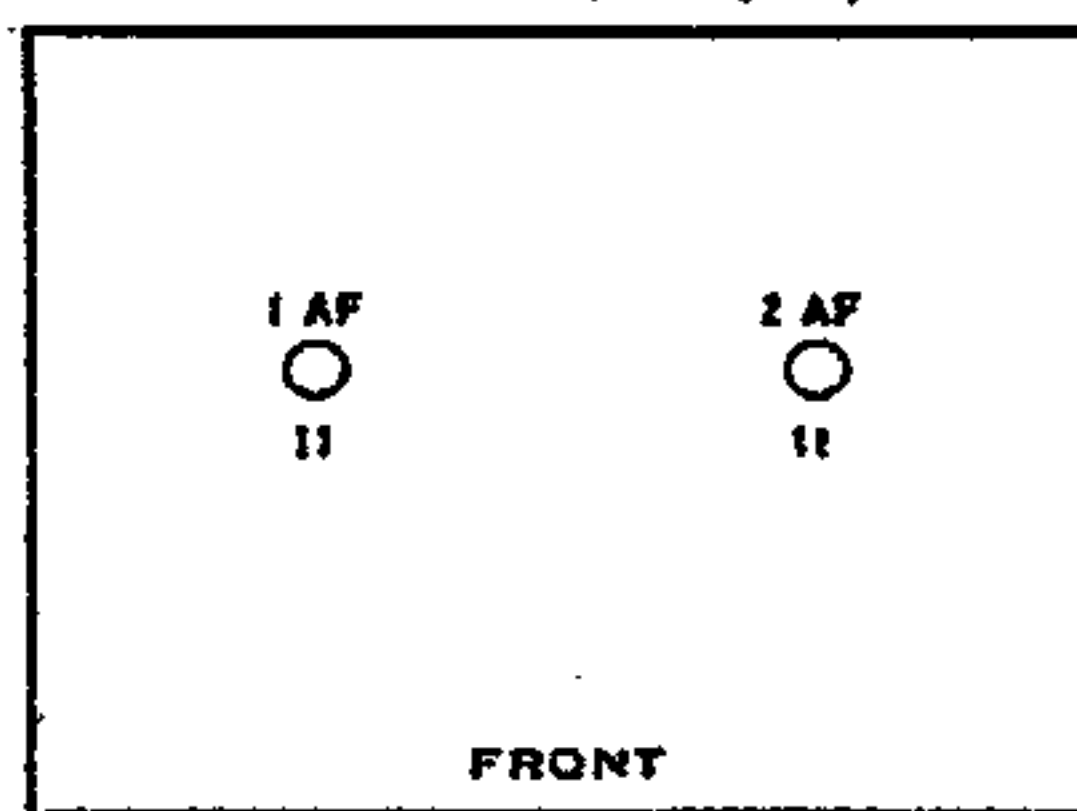

Model Radiola II

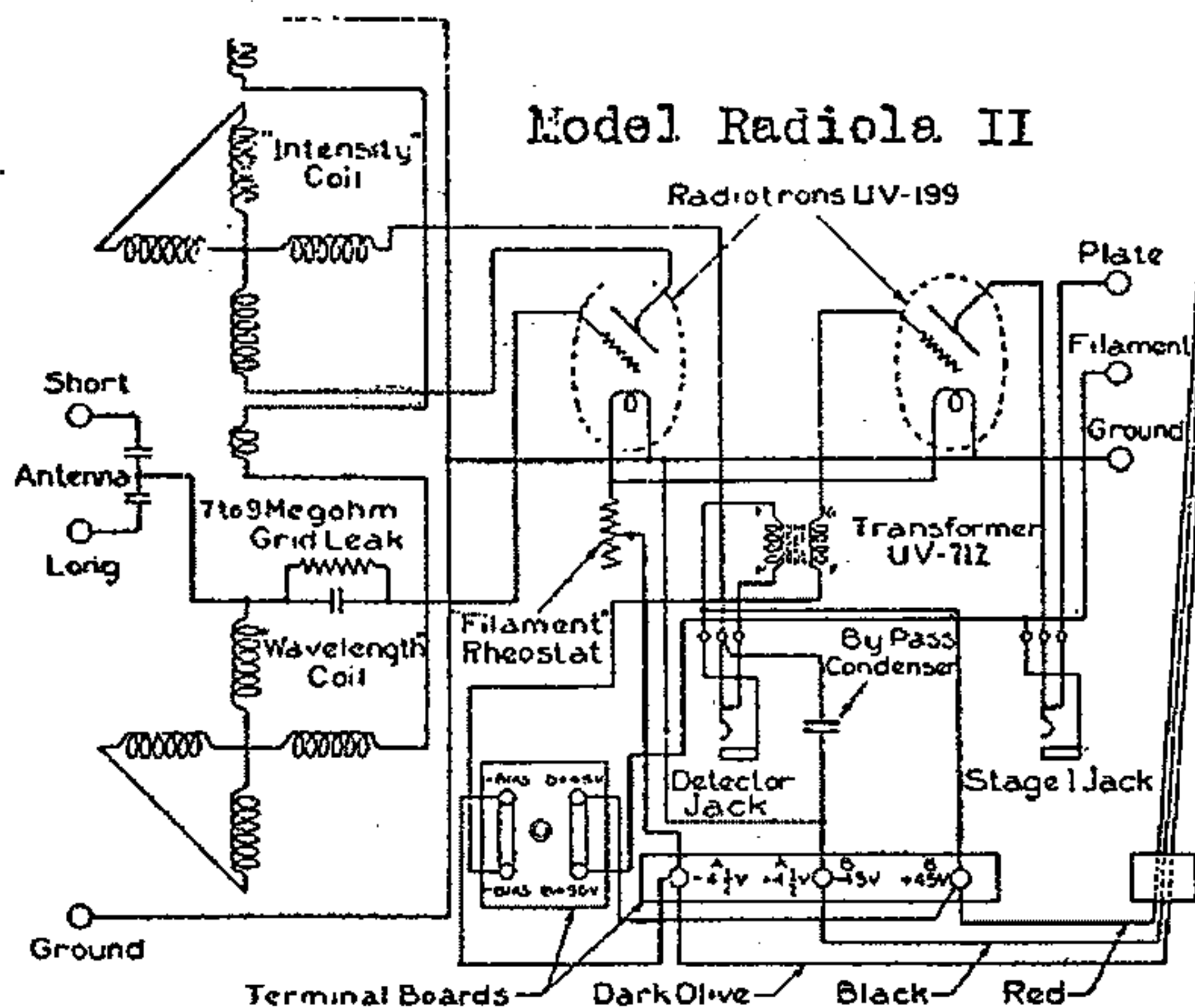

Two Flashlight Batteries  
 4 1/2 Volts 1 1/2 Dia. x 7"

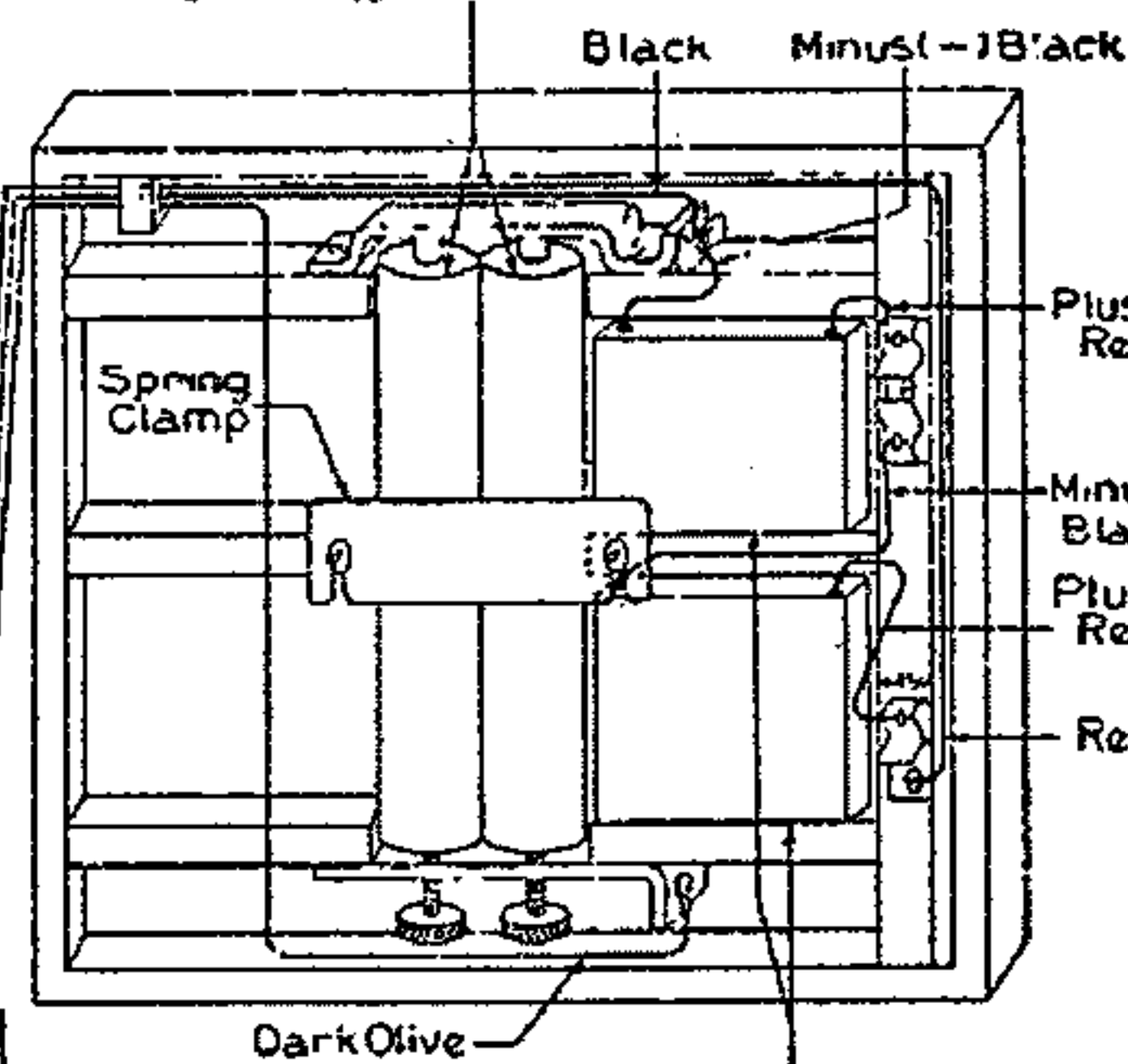

Model Radiola II (1924)

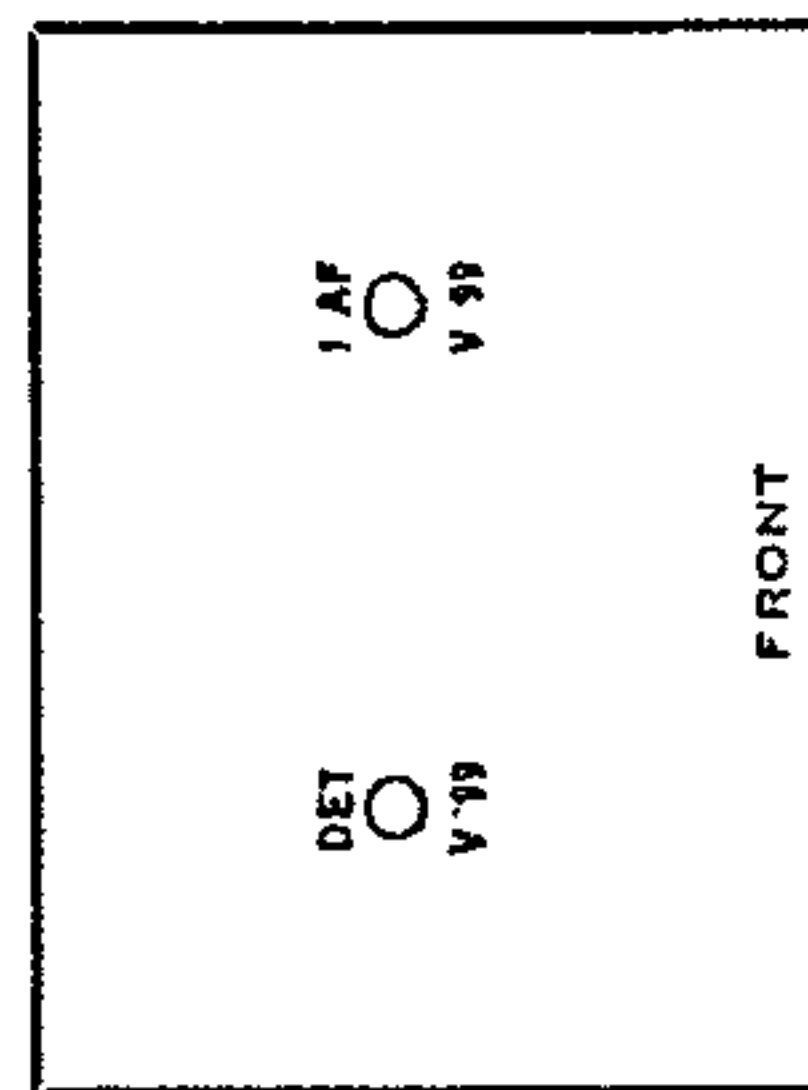

Model Balanced Amp.

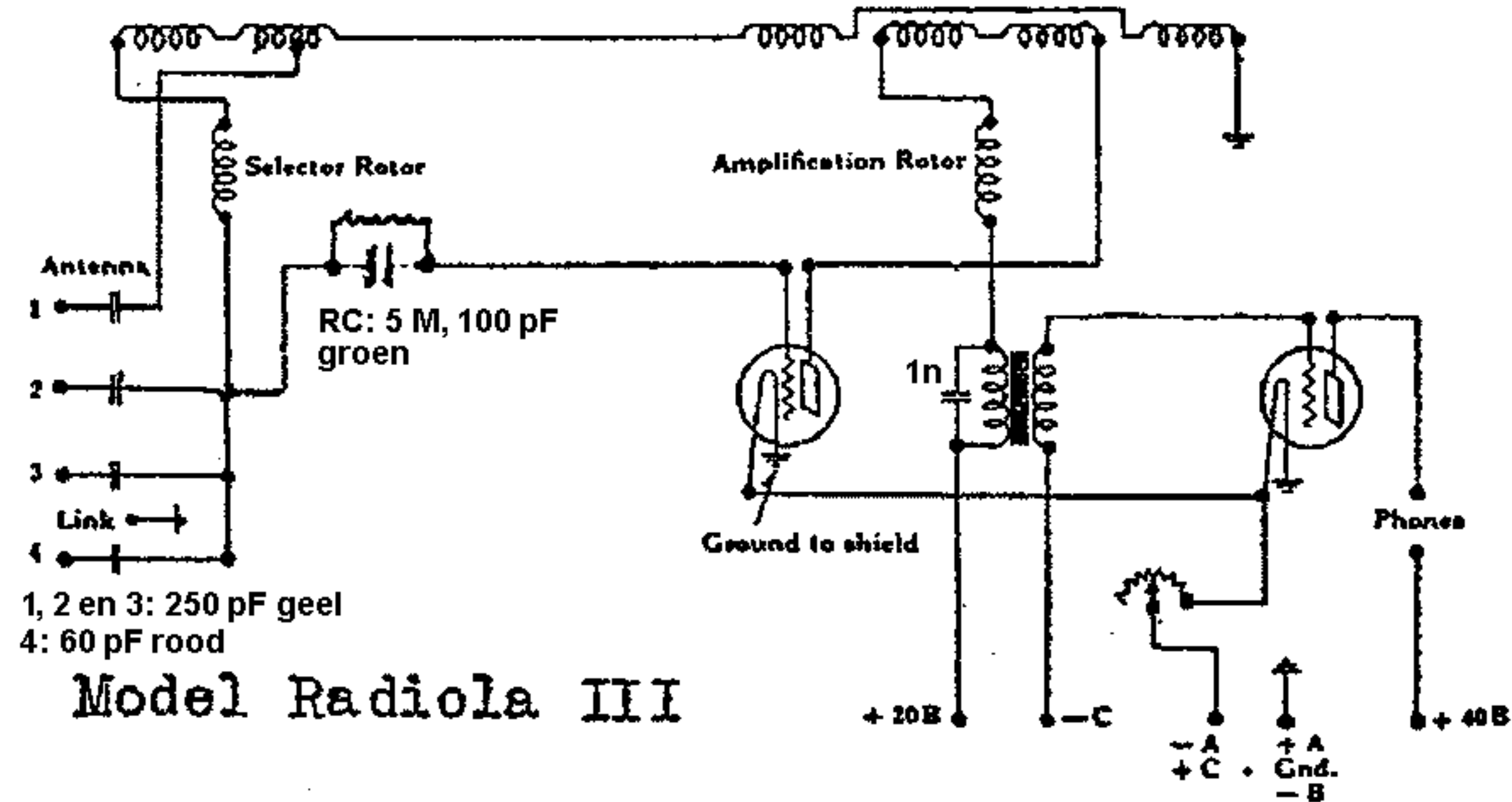

Model Radiola III

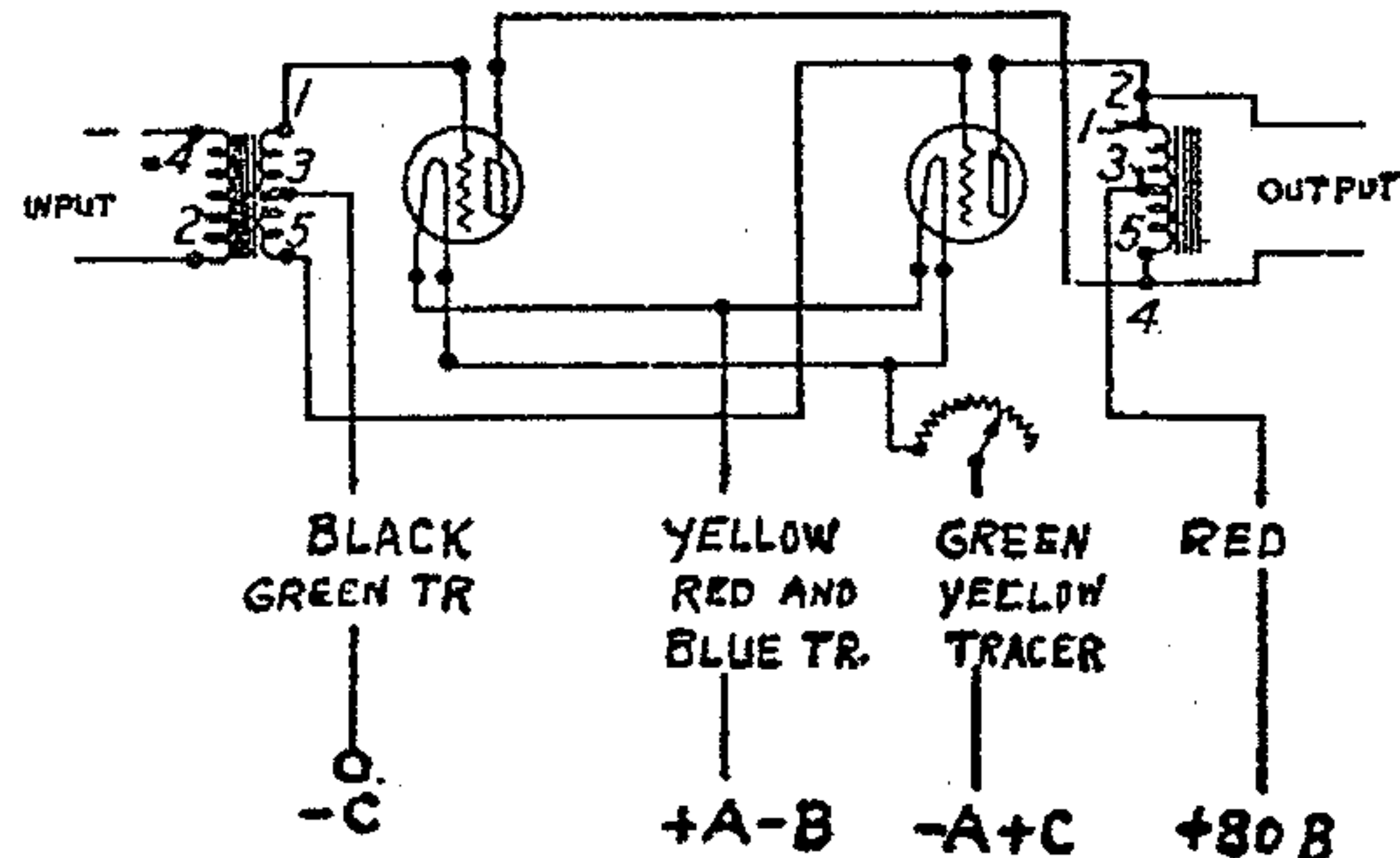

Model Radiola Balanced Amplifier (1924)

Model Radiola III (1924)

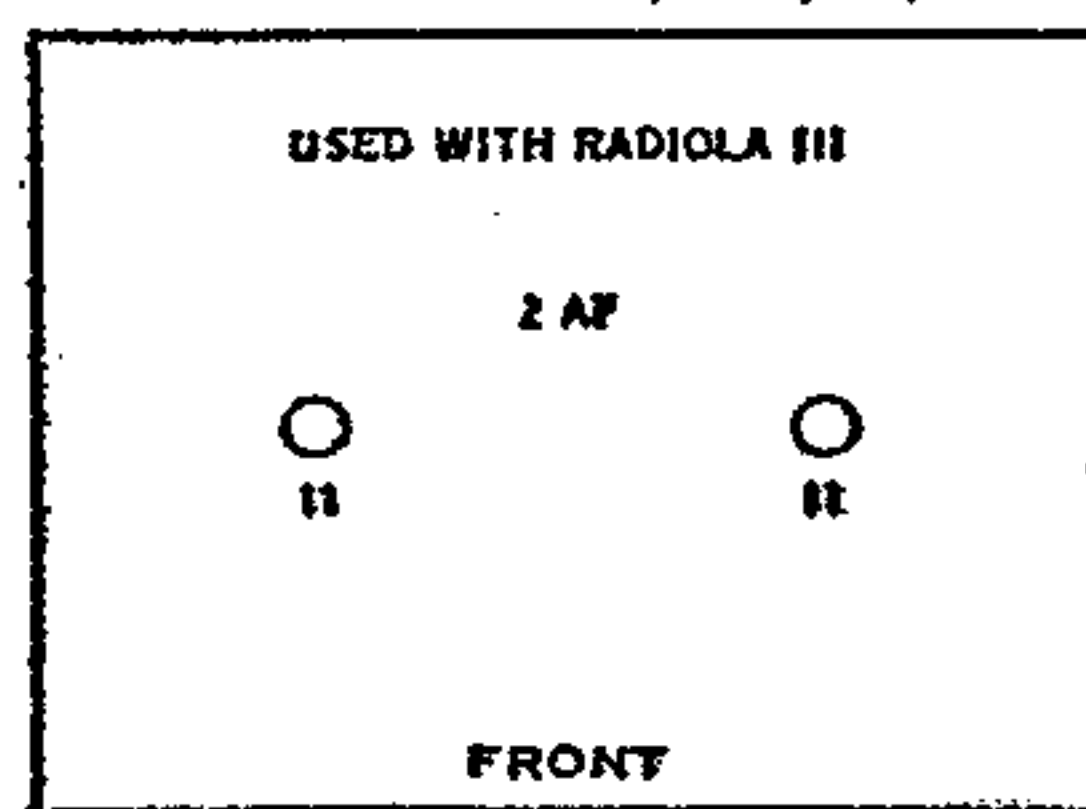
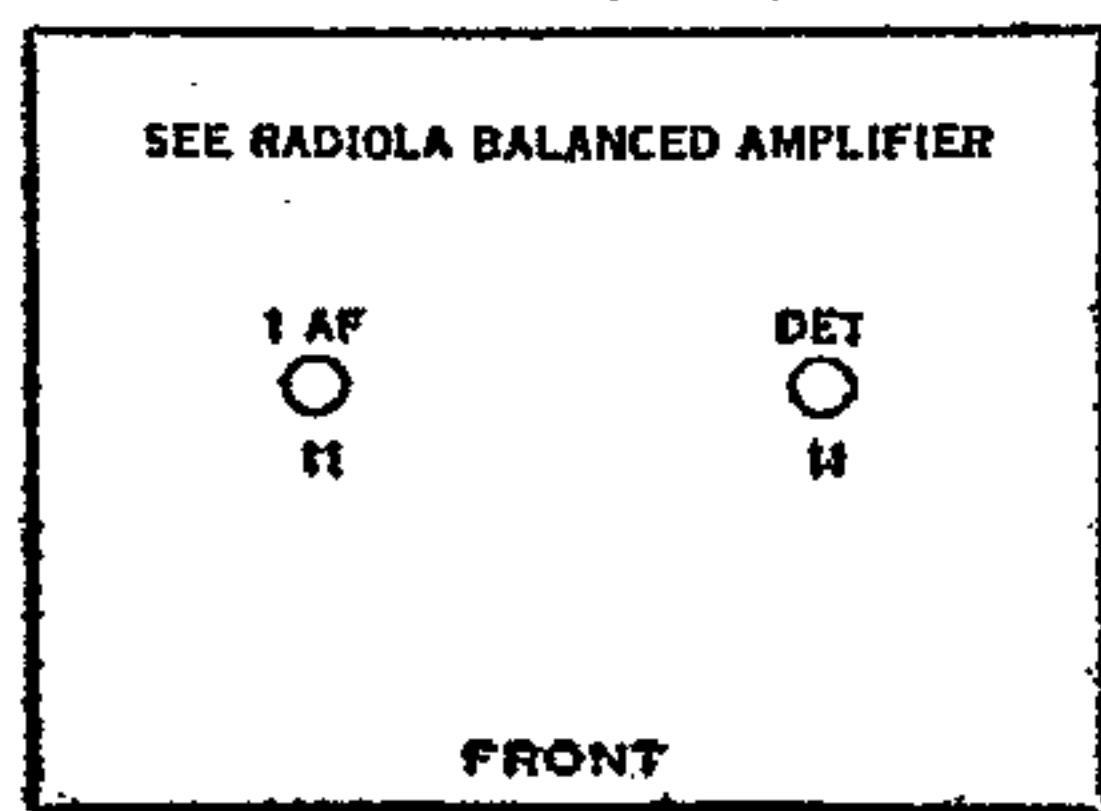

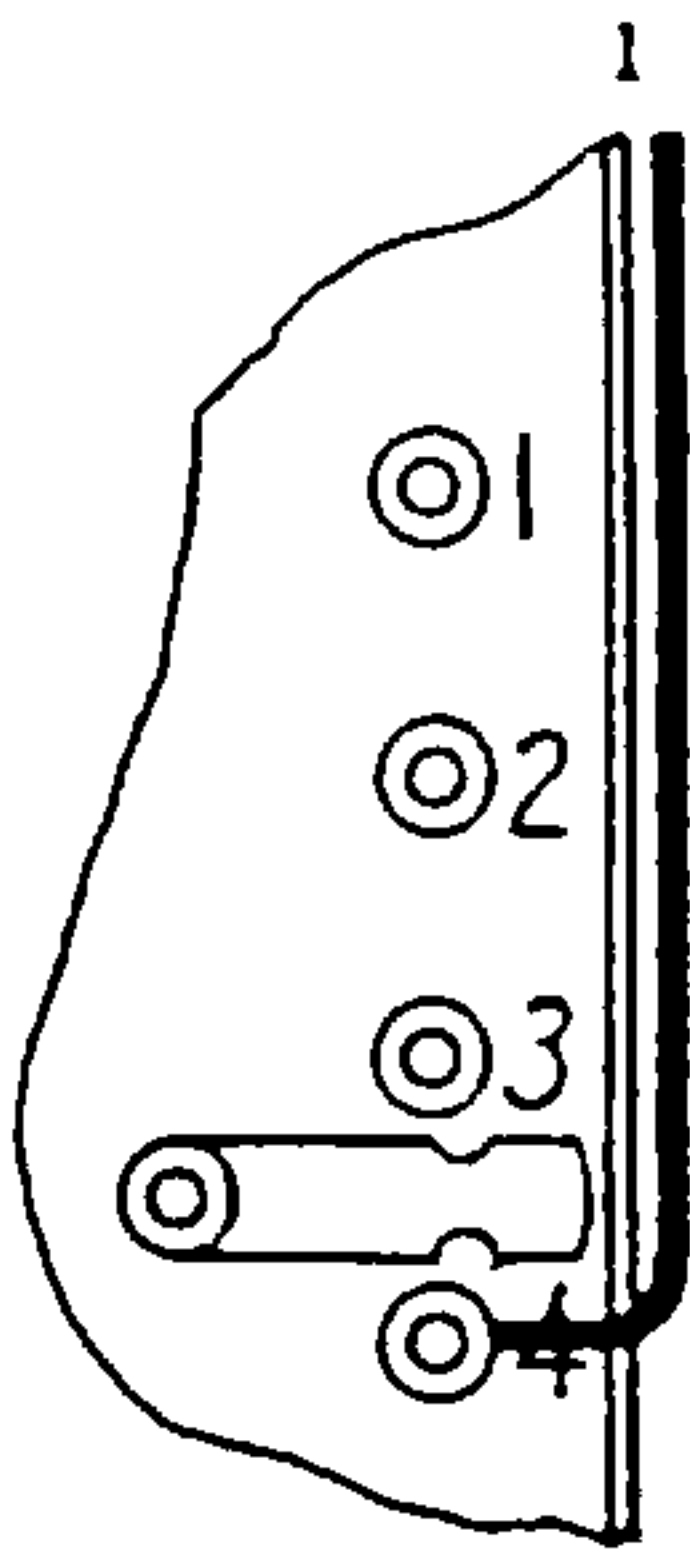

**Short Wave  
Single Circuit**

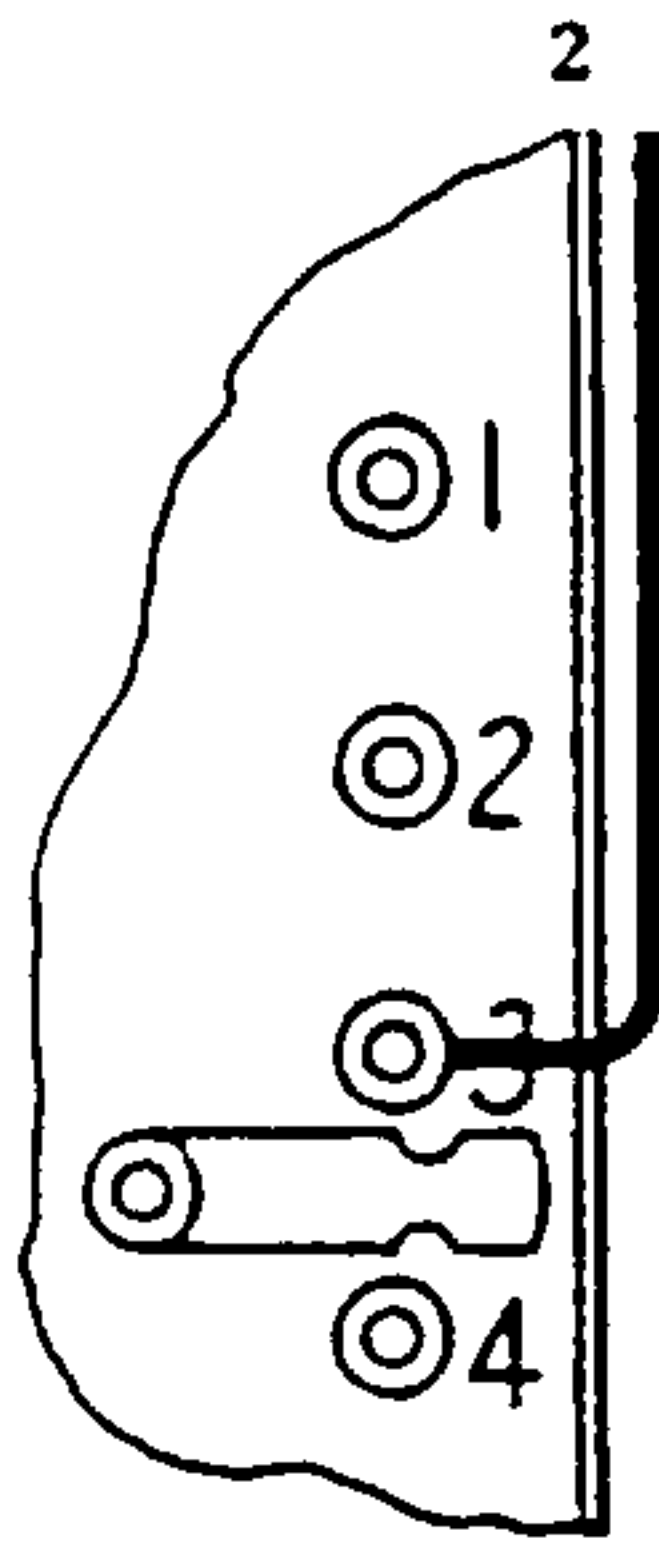

**Medium Wave  
Single Circuit**

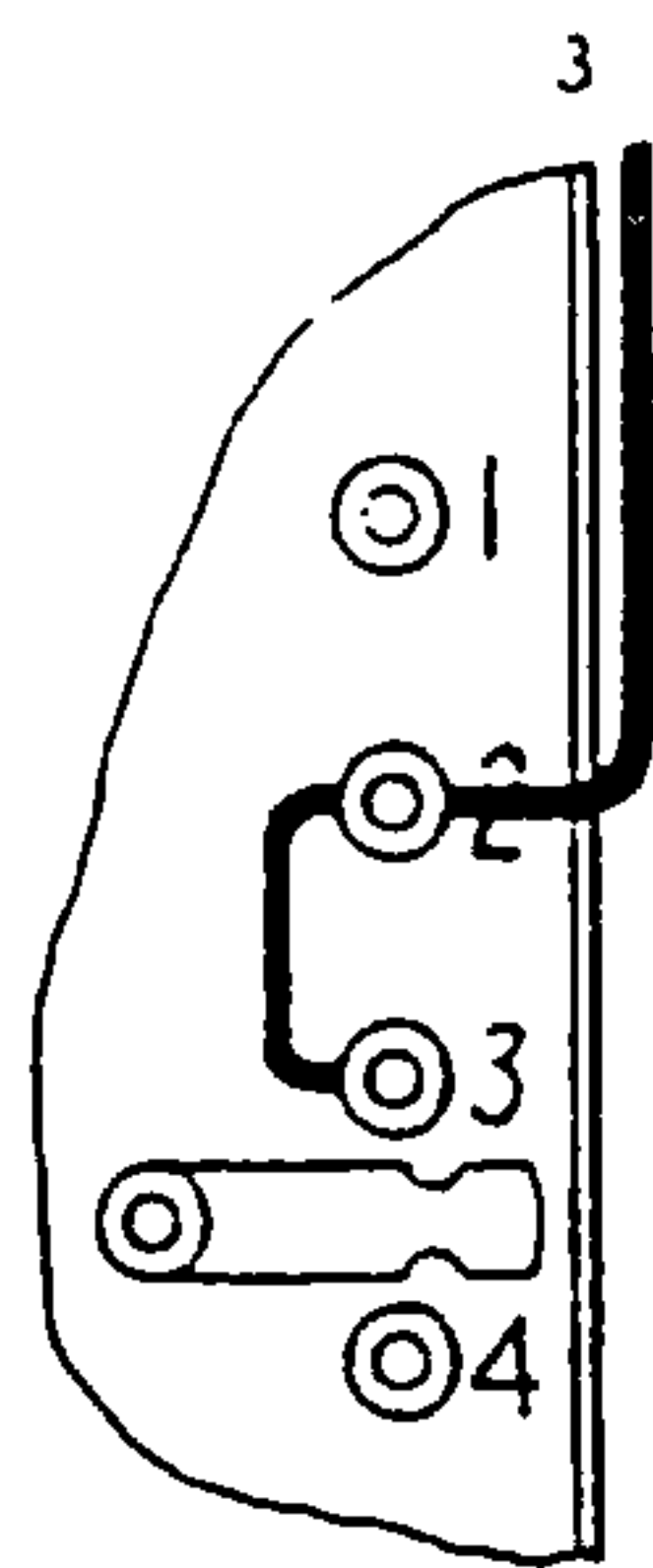

**Long Wave  
Single Circuit**

**For any Antenna**

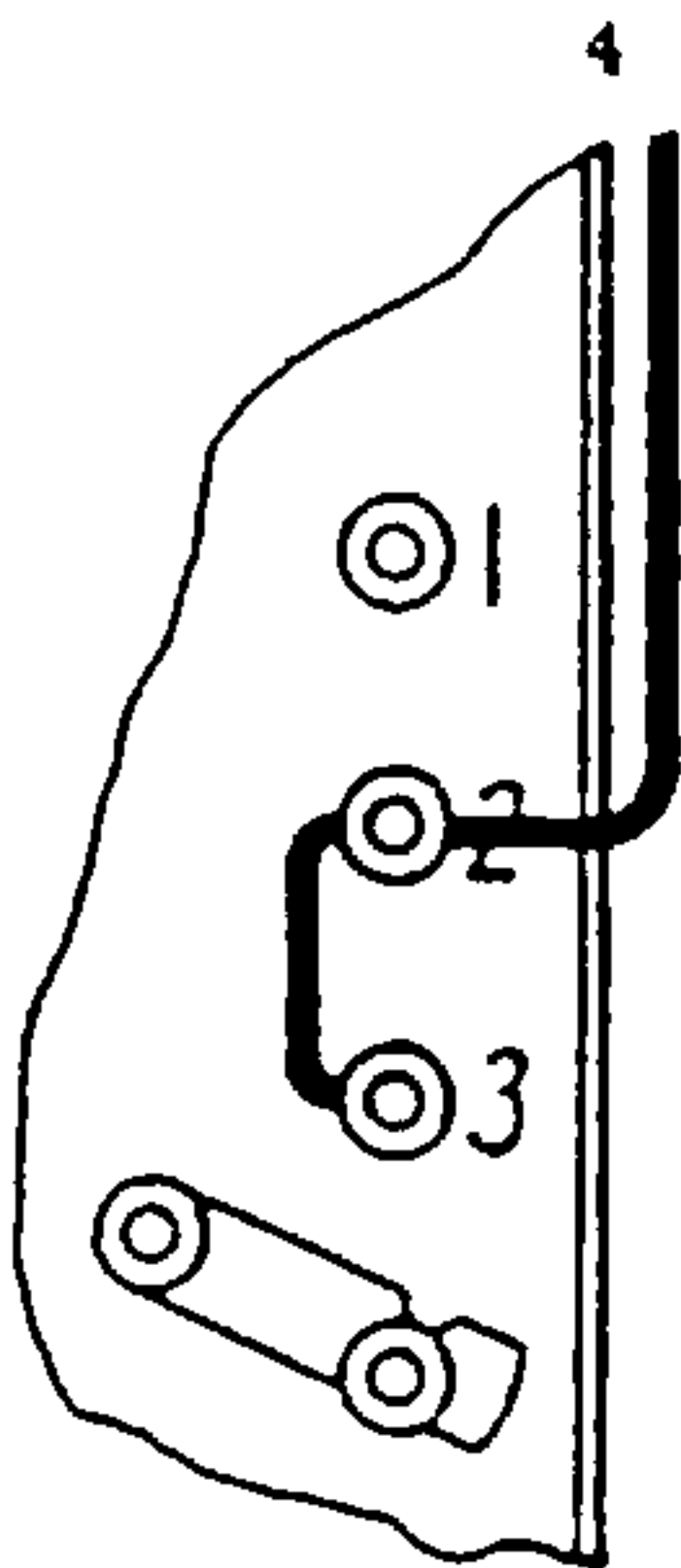

**Long Wave  
for very  
Small Antenna**

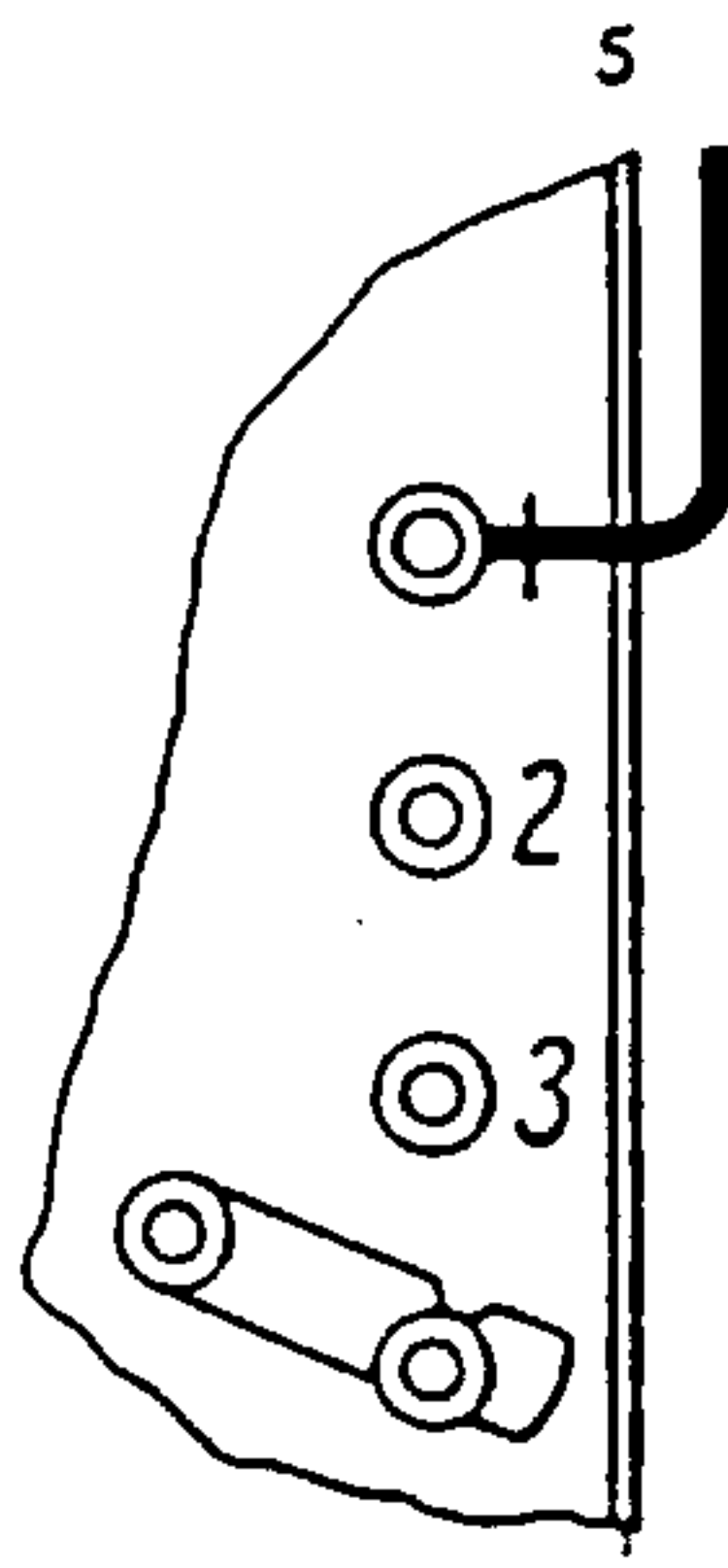

**Short Wave  
Selective  
Circuit**

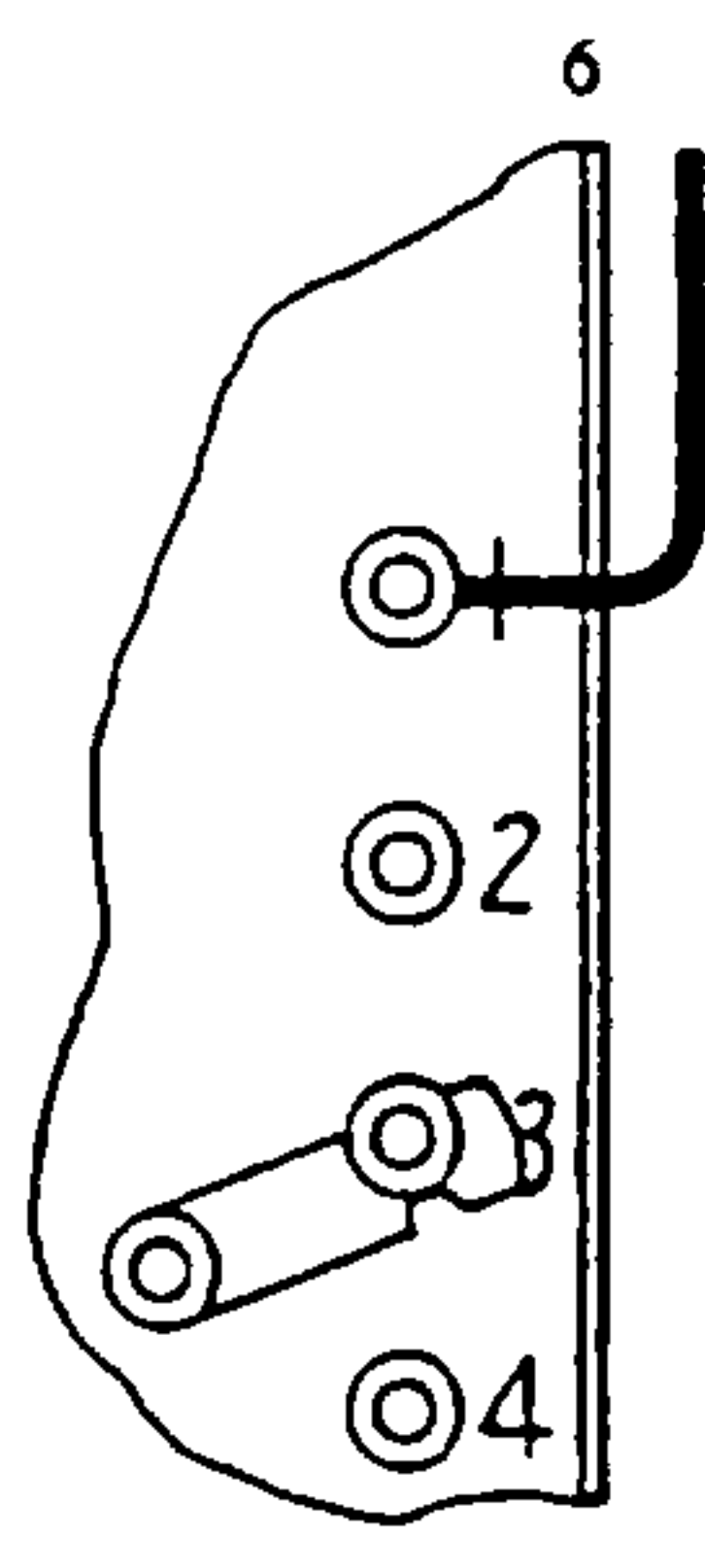

**Long Wave  
Selective  
Circuit**

**For any Antenna**

**Fig. 3—Showing Antenna Connections to Different Binding Posts**