

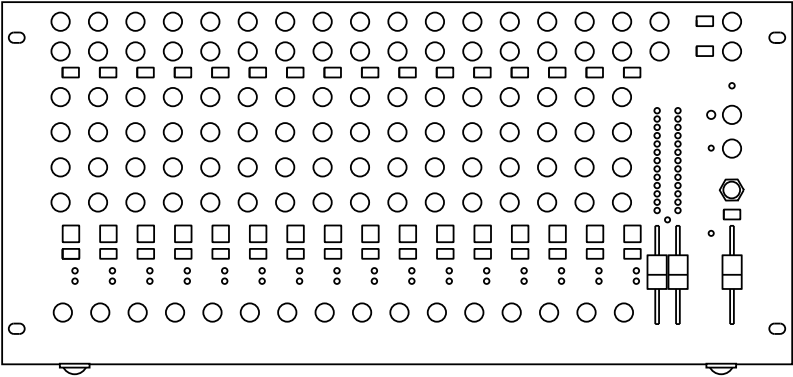

MACKIE.®

LM3204

32 INPUT, 2+2 BUS MIXER

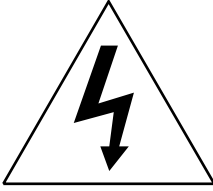

SERVICE MANUAL

| | |
|--|--|
|  <h2 style="margin: 0;">CAUTION AVIS</h2> <p style="margin: 0;">RISK OF ELECTRIC SHOCK DO NOT OPEN <i>RISQUE DE CHOC ELECTRIQUE NE PAS OUVRIR</i></p>  | |
| <p>CAUTION: TO REDUCE THE RISK OF ELECTRIC SHOCK DO NOT REMOVE THE COVER (OR BACK) NO USER SERVICEABLE PARTS INSIDE REFER SERVICING TO QUALIFIED PERSONNEL</p> <p>WARNING: TO REDUCE THE RISK OF FIRE OR ELECTRIC SHOCK, DO NOT EXPOSE THIS PRODUCT TO RAIN OR MOISTURE</p> <p>TO PREVENT ELECTRIC SHOCK, DO NOT USE THIS POLARIZED PLUG WITH AN EXTENSION CORD, RECEPTACLE OR OTHER OUTLET UNLESS THE BLADES CAN BE FULLY INSERTED TO PREVENT BLADE EXPOSURE.</p> | <p><i>ATTENTION: POUR EVITER LES RISQUES DE CHOC ELECTRIQUE, NE PAS ENLEVER LE COUVERCLE. AUCUN ENTRETIEN DE PIECES INTERIEURES PAR L'USAGER. CONFIER L'ENTRETIEN AU PERSONNEL QUALIFIE.</i></p> <p><i>AVIS: POUR EVITER LES RISQUES D'INCENDIE OU D'ELECTROCUTION, N'EXPOSEZ PAS CET ARTICLE A LA PLUIE OU A L'HUMIDITE.</i></p> <p><i>POUR PREVENIR LES CHOCS ELECTRIQUES NE PAS UTILISER CETTE FICHE POLARISEE AVEC UN PROLONGATEUR, UN PRISE DE COURANT OU UNE AUTRE SORTIE DE COURANT, SAUF SI LES LAMES PEUVENT ETRE INSEREES A FOND SANS LAISSER AUCUNE PARTIE A DECOUVERT.</i></p> |
| <p>This apparatus does not exceed the Class A/Class B (whichever is applicable) limits for radio noise emissions from digital apparatus as set out in the radio interference regulations of the Canadian Department of Communications.</p> <p>ATTENTION :Le présent appareil numérique n'émet pas de bruits radioélectriques dépassant les limites applicables aux appareils numériques de class A/de class B (selon le cas) prescrites dans le règlement sur le brouillage radioélectrique édicté par les ministere des communications du Canada.</p> <p>This equipment has been tested and found to comply with the limits for a Class A digital device, pursuant to part 15 of the FCC rules. These limits are designed to provide reasonable protection against harmful interference when the equipment is operated in a commercial environment. This equipment generates, uses, and can radiate radio energy and, if not installed properly and used in accordance with the instruction manual, may cause harmful interference to radio communications. Operation of this equipment in a residential area is likely to cause harmful interference in which case the user will be required to correct the interference at his own expense.</p> | |



The lightning flash with arrowhead symbol within an equilateral triangle is intended to alert the user to the presence of uninsulated "dangerous voltage" within the product's enclosure, that may be of sufficient magnitude to constitute a risk of electric shock to persons.

Le symbole éclair avec point de flèche à l'intérieur d'un triangle équilatéral est utilisé pour alerter l'utilisateur de la présence à l'intérieur du coffret de "voltage dangereux" non isolé d'ampleur suffisante pour constituer un risque d'électrocution.



The exclamation point within an equilateral triangle is intended to alert the user of the presence of important operating and maintenance (servicing) instructions in the literature accompanying the appliance.

Le point d'exclamation à l'intérieur d'un triangle équilatéral est employé pour alerter les utilisateurs de la présence d'instructions importantes pour le fonctionnement et l'entretien (service) dans le livret d'instruction accompagnant l'appareil.

CONTENTS

INTRODUCTION 3
 Technical Support 3
 Disclaimer 3
 BLOCK DIAGRAM 4
 QUICK PARTS 5-6
 FOLD-OUT SECTIONS:
 Front Board Schematics and PCB Layout 17-1
 Rear Board Schematics and PCB Layout 18-1
 Meter Board Schematics and PCB Layout 24-1
 Power Supply Schematics and PCB Layout 25-1

INTRODUCTION

| | | |
|---|---|---|
|  | <p>SERVICE ON THIS EQUIPMENT IS TO BE PERFORMED BY EXPERIENCED REPAIR TECHNICIANS ONLY <i>CONFIER L'ENTRETIEN AU PERSONNEL QUALIFIE</i></p> |  |
|---|---|---|

This manual contains basic service information. It is essential that you have a copy of the user's manual as this contains the complete operating instructions.



TECHNICAL SUPPORT

Mackie Designs Technical Support Department is available 8AM - 5PM PST, Monday-Friday at 1-800-258-6883. Feel free to call with any questions and to speak with a carefully-calibrated technician.

DISCLAIMER

The information contained in this manual is proprietary to Mackie Designs, Inc. The entire manual is protected under copyright and may not be reproduced by any means without express written permission from Mackie Designs, Inc.

BLOCK DIAGRAM

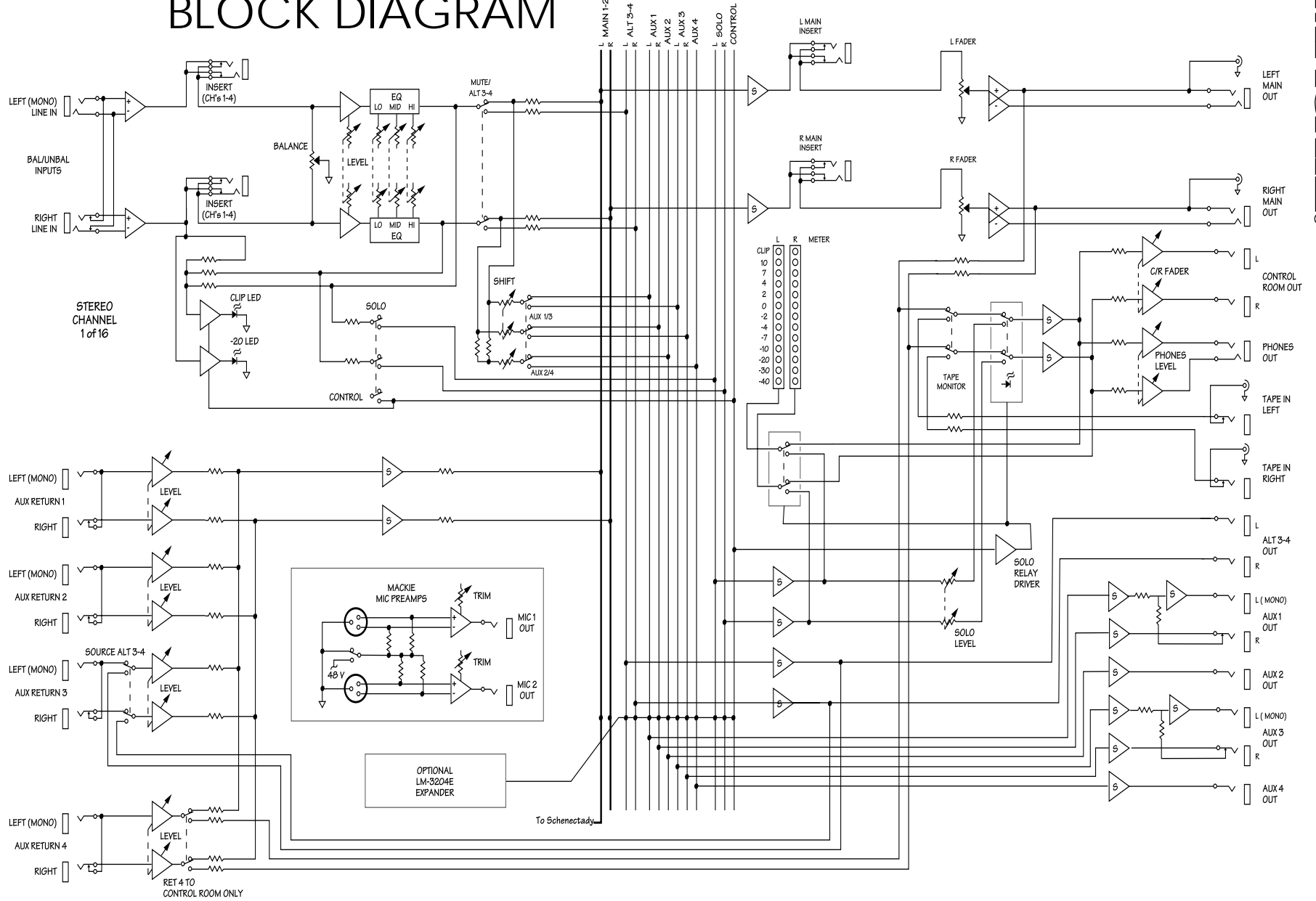

QUICK PARTS

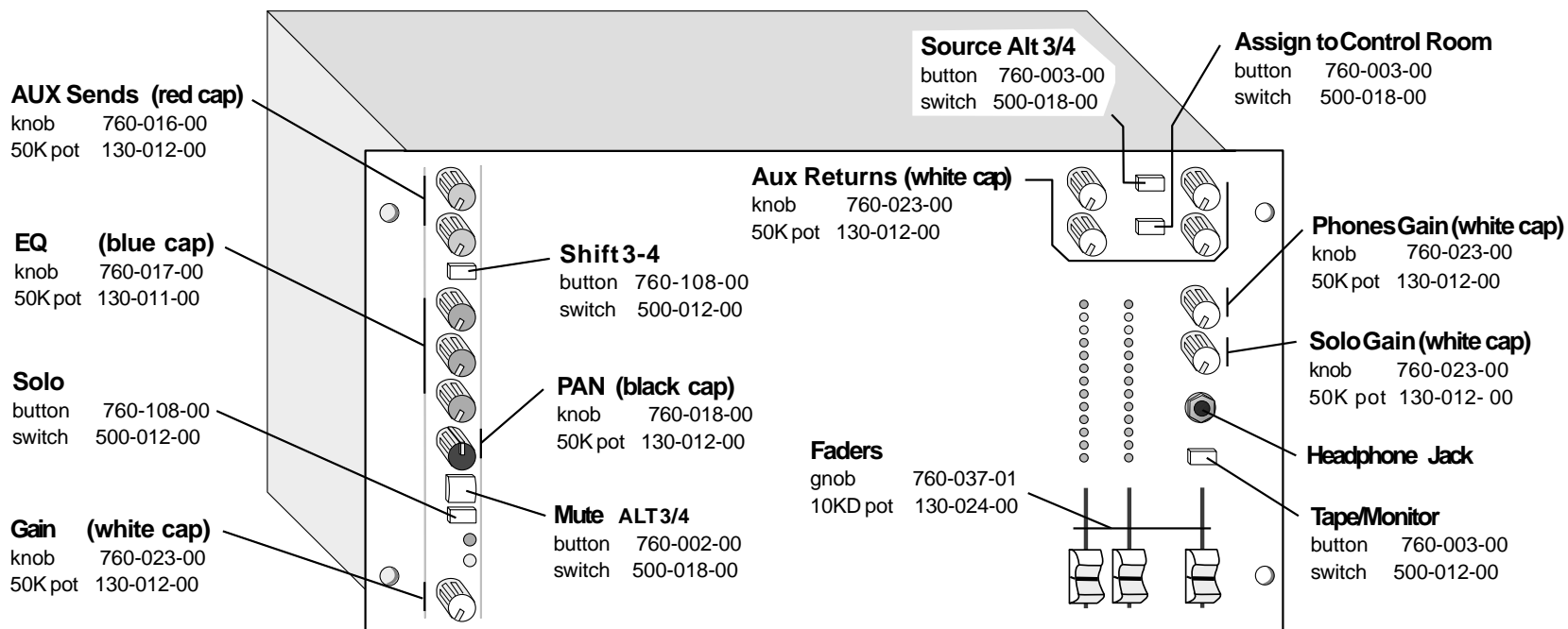

...More Stuff...

LEDs

| | |
|-----------|------------|
| Rude lite | 304-002-00 |
| Red | 304-001-00 |
| Yellow | 304-003-00 |
| Green | 304-004-00 |

Owners Manual

820-009-00

Phantom Switch

| | |
|----------|------------|
| button | 760-003-00 |
| extender | 760-015-00 |
| switch | 500-018-00 |

LineCord 6' IEC

10A 640-001-00

XLR Female Jack

400-002-01

RCAQuad

400-022-00

1/4" Female Jack

| | |
|--------|------------|
| jack | 400-214-00 |
| nut | 705-003-00 |
| washer | 710-002-00 |

Trim Control

| | |
|---------|------------|
| knob | 760-007-00 |
| 5KZDpot | 130-020-00 |

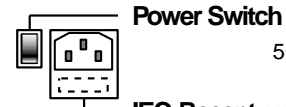

Power Switch

500-013-00

IEC Recept. w/fuse

| | |
|-----------|------------|
| holder | 400-009-00 |
| 110V fuse | 510-001-00 |
| 220V fuse | 510-002-00 |
| 100V fuse | 510-001-00 |

05/99

QUICK SCREWS

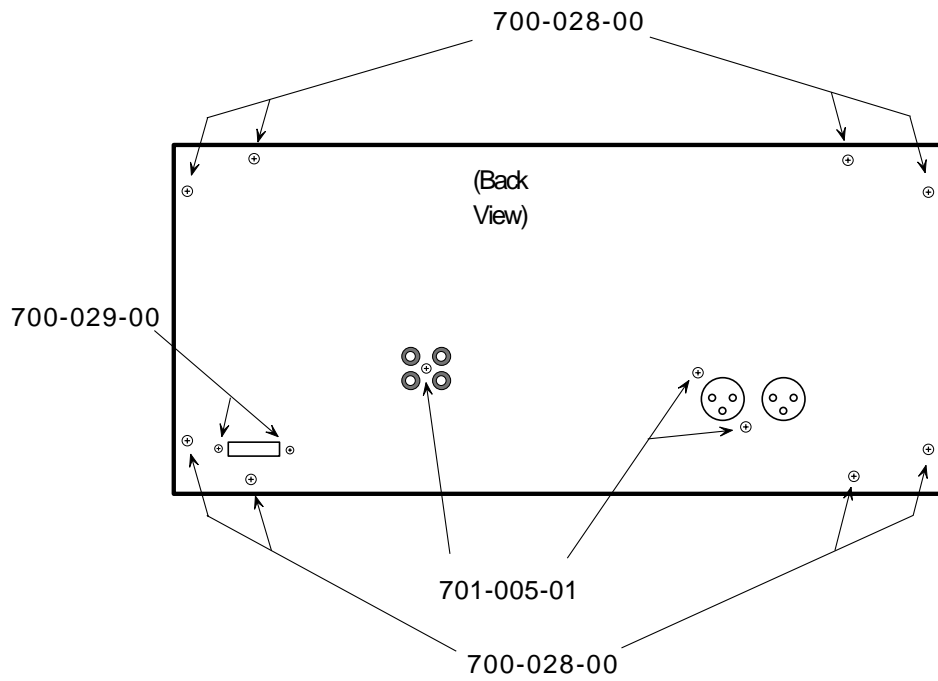
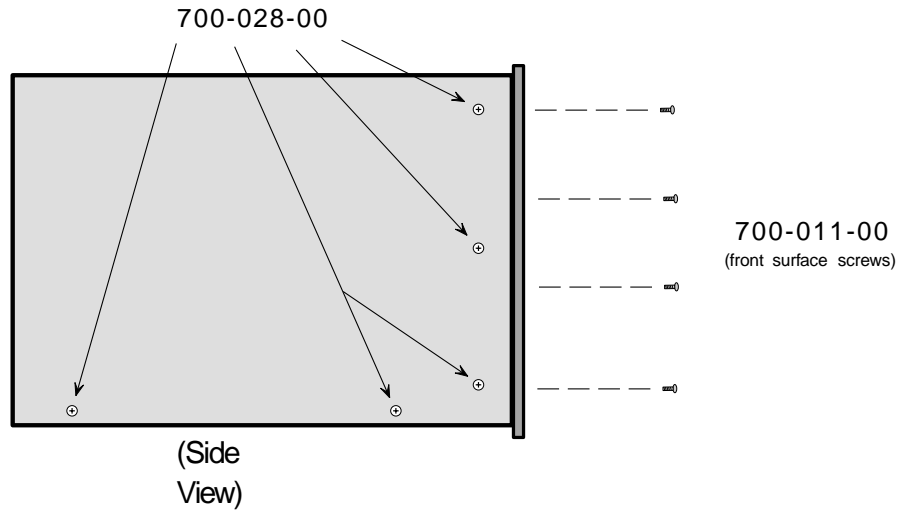

Version 1.0