

CIRCUIT BOARD DIAGRAM

H33

Hita chi WH-837F

VARIABLE CONDENSER
CO02 CO01

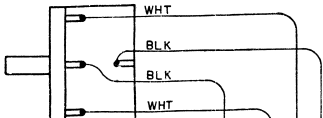

MIDZET VARIABLE CONDENSER
CO22

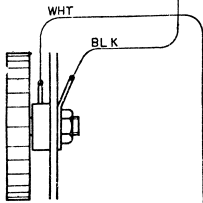

FERRITE-CORE ANTENNA

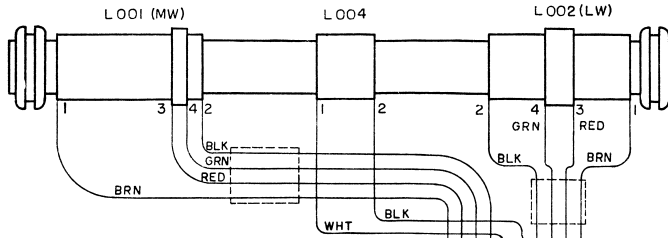

ON-OFF SWITCH & VOLUME CONTROL

TELESCOPIC AERIAL

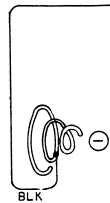
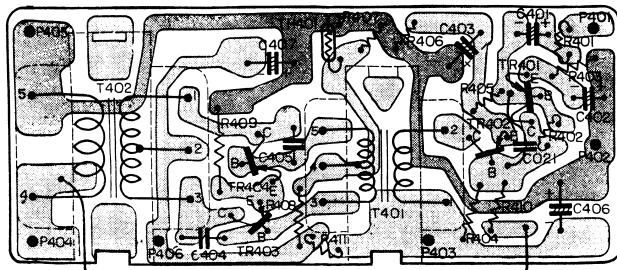
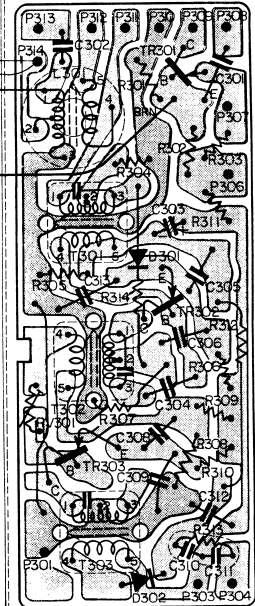
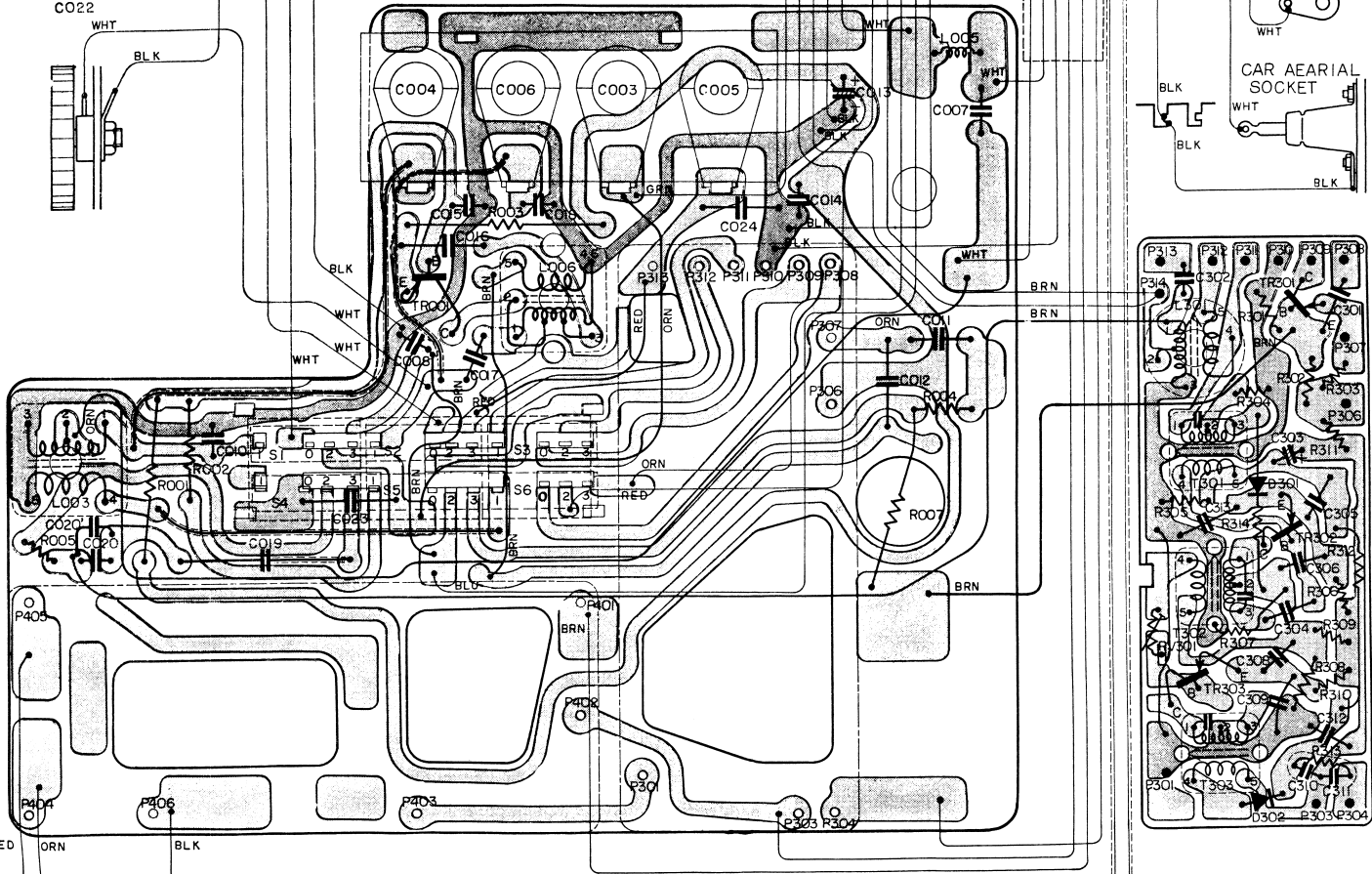
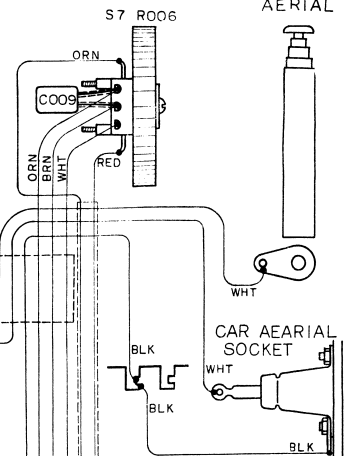

BATTERY

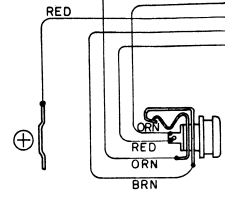

J002
EARPHONE JACK

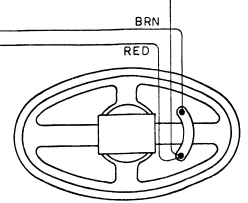

SPO01
4" x 2 1/2" SPEAKER

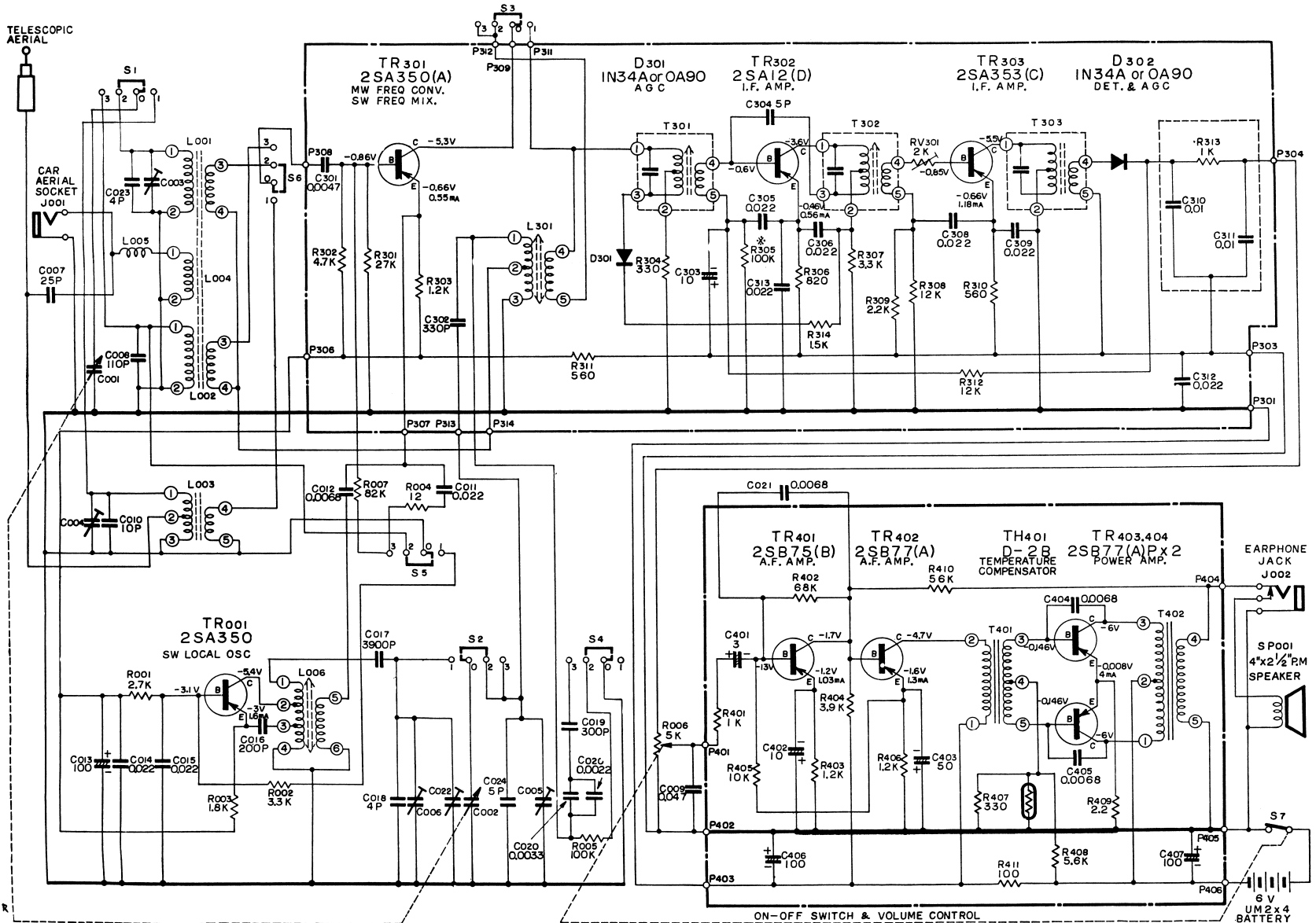

Note : C 007 is changed to 20 pF and
R 004 is changed to 56Ω.