

SERVICE INFORMATION

XRS10P POWERED LOUDSPEAKER

CONTENTS:

OPERATION MANUAL

SCHEMATIC DIAGRAM

XRS SERIES

POWERED AND PASSIVE LOUDSPEAKERS INSTALLATION AND OPERATION MANUAL

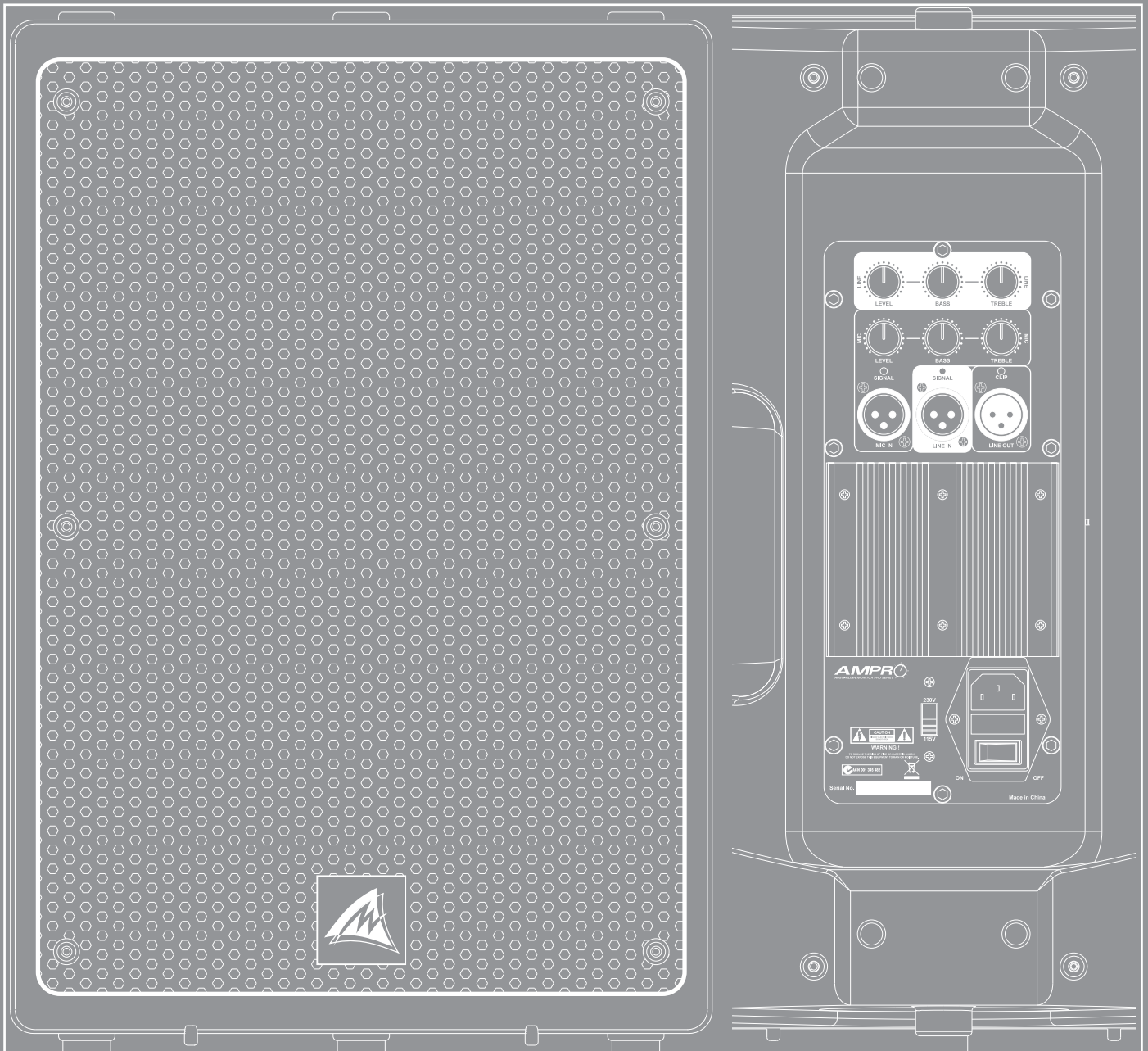



IMPORTANT SAFETY INFORMATION





1. Save the carton and packing material even if the equipment has arrived in good condition. Should you ever need to ship the unit, use only the original factory packing.
2. Read all documentation before operating your equipment. Retain all documentation for future reference.
3. Follow all instructions printed on unit chassis for proper operation.
4. Do not spill water or other liquids into or on the unit, or operate the unit while standing in liquid.
5. Make sure power outlets conform to the power requirements listed on the back of the unit.
6. Do not use the unit if the electrical power cord is frayed or broken. The power supply cords should be routed so that they are not likely to be walked on or pinched by items placed upon or against them, paying particular attention to cords and plugs, convenience receptacles, and the point where they exit from the appliance.
7. Always operate the unit with the AC ground wire connected to the electrical system ground. Precautions should be taken so that the means of grounding of a piece of equipment is not defeated.
8. Mains voltage must be correct and the same as that printed on the rear of the unit. Damage caused by connection to improper AC voltage is not covered by any warranty.
9. Have gain controls on amplifiers turned down during power-up to prevent speaker damage if there are high signal levels at the inputs.
10. Power down and disconnect units from mains voltage before making connections.
11. Never hold a power switch in the "ON" position if it won't stay there itself!
12. Do not use the unit near stoves, heat registers, radiators, or other heat producing devices.
13. Do not block fan intake or exhaust ports. Do not operate equipment on a surface or in an environment which may impede the normal flow of air around the unit, such as a bed, rug, weathersheet, carpet, or completely enclosed rack. If the unit is used in an extremely dusty or smoky environment, the unit should be periodically "blown free" of foreign matter.
14. Do not remove the cover. Removing the cover will expose you to potentially dangerous voltages. There are no user serviceable parts inside.
15. Do not drive the inputs with a signal level greater than that required to drive equipment to full output.
16. Do not connect the inputs / outputs of amplifiers or consoles to any other voltage source, such as a battery, mains source, or power supply, regardless of whether the amplifier or console is turned on or off.
17. Do not run the output of any amplifier channel back into another channel's input. Do not parallel- or series-connect an amplifier output with any other amplifier output. Australian Monitor is not responsible for damage to loudspeakers for any reason.
18. Do not ground any "hot" (red) terminal. Never connect a "hot" (red) output to ground or to another "hot" (red) output!
19. Non-use periods: the power cord of equipment should be unplugged from the outlet when left unused for a long period of time.
20. Service Information Equipment should be serviced by qualified service personnel when:
 - A. The power supply cord or the plug has been damaged.
 - B. Objects have fallen, or liquid has been spilled into the equipment
 - C. The equipment has been exposed to rain
 - D. The equipment does not appear to operate normally, or exhibits a marked change in performance
 - E. The equipment has been dropped, or the enclosure damaged.

Building on the reliability and sonic quality of the very popular XR speaker series, Australian Monitor brings you the AM Pro XRS two way injection moulded speaker enclosures with more features and new aesthetic to suit both live sound reinforcement and permanent installation. From Front of House to fold back, the dance floor to background fill, the XRS series with both passive and powered options are designed with flexibility and performance in mind.

The AM Pro XRS range includes 8", 10" and 12" models all with high quality compression drivers and represent a significant advancement in injection moulded box design while maintaining excellent audio quality and great value for money.

INTRODUCTION	3
FRONT AND REAR PASSIVE PANEL	4
REAR POWERED PANEL	5
SPECIFICATIONS	6

AUS, EUR, USA
REV A 24th Nov 2008

	CAUTION RISK OF ELECTRIC SHOCK DO NOT OPEN	
<p>CAUTION: TO REDUCE THE RISK OF ELECTRIC SHOCK, DO NOT REMOVE COVER (OR BACK), NO USER SERVICEABLE PARTS INSIDE, REFER SERVICING TO QUALIFIED SERVICE PERSONNEL.</p>		



This symbol is intended to alert the user to the presence of uninsulated "dangerous voltage" within the products enclosure that may be of sufficient magnitude to constitute a risk of electric shock to persons.



This symbol is intended to alert the user to the presence of important operational and maintenance (servicing) instructions in the literature accompanying the appliance.

Caution:

To prevent electric shock do not use this (polarised) plug with an extension cord, receptacle or other outlet unless the blades can be fully inserted to prevent blade exposure. To prevent electric shock, match wide blade of plug to wide slot, fully insert.

WARNING!

TO REDUCE THE RISK OF FIRE OR ELECTRIC SHOCK
DO NOT EXPOSE THIS EQUIPMENT TO RAIN OR MOISTURE.

FRONT AND REAR PANEL PASSIVE VERSION

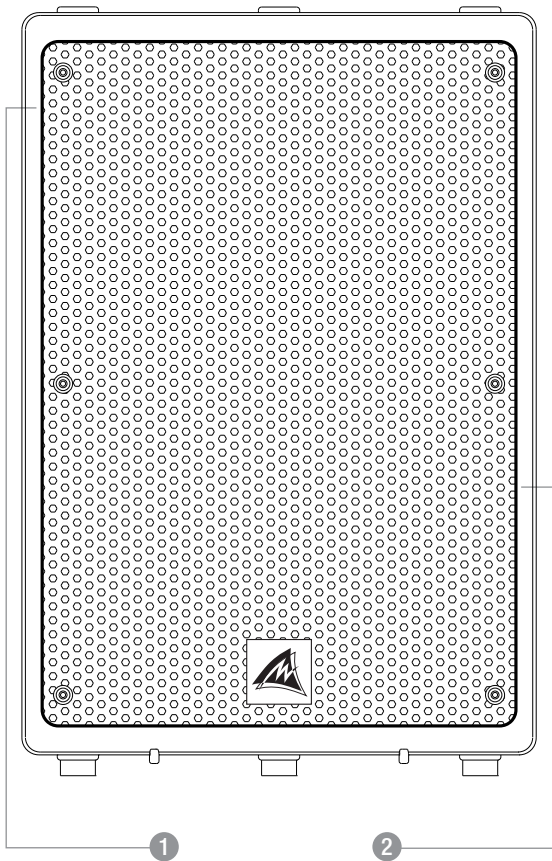

1 High Frequency Driver

Horn loaded compression driver. Directivity 90deg x 90deg.

Passive crossover in the XRS8/10/12.

XRS8/XRS8P 1.5"

XRS10/XRS10P 1.5"

XRS12/XRS12P 2"

Active crossover and power amp in XRS8P/10P/12P.

XRS8P 50W

XRS10P 50W

XRS12P 100W

2 Low Frequency Woofer

Driver sizes:

XRS8/XRS8P 8"

XRS10/XRS10P 10"

XRS12/XRS12P 12"

Active crossover and power amp in XRS8P/10P/12P.

XRS8P 100W

XRS10P 100W

XRS12P 300W

Note that the XRS8 ships as a pair.

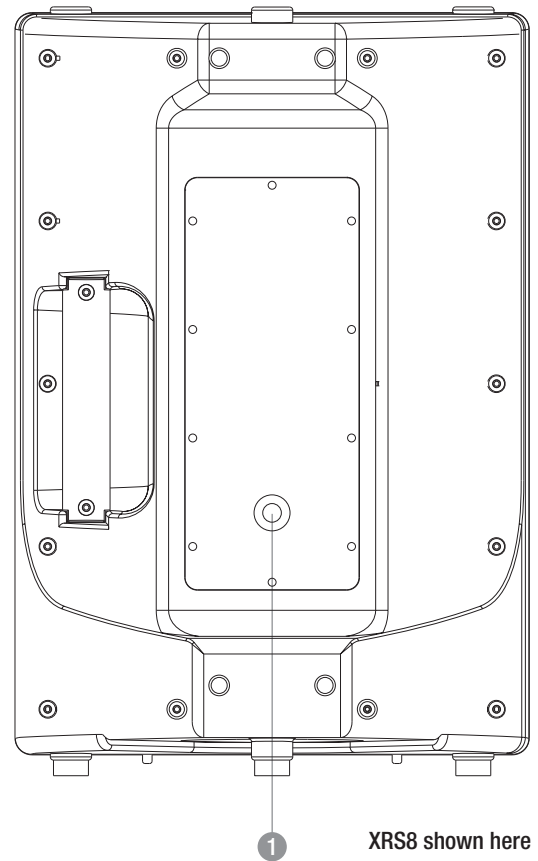

1 Speaker Input

The input connector is a 4 pole speakon compatible connector. Pins 1+ and 1- are wired to the +ve and -ve respectively of the speaker. The XRS10 and XRS12 have 2 connectors. They are wired in parallel so either connector can be used as an input, the other as a loop through.

Accessories:

XRS8/XRS8P

XR8PMA Pole mount adapter

XR8UMB Universal mounting bracket

XRS10/XRS10P

XR10CVR Heavy duty cover

AMISLSB1 Wall mount brackets

ATC303 Tripod speaker stand

ATC304 Heavy duty tripod speaker stand

ATC305 Winch up speaker stand

XR10-12UB Universal bracket

XRS12/XRS12P

XR12CVR Heavy duty cover

AMISLSB1 Wall mount brackets

ATC303 Tripod speaker stand

ATC304 Heavy duty tripod speaker stand

ATC305 Winch up speaker stand

XR10-12UB Universal bracket

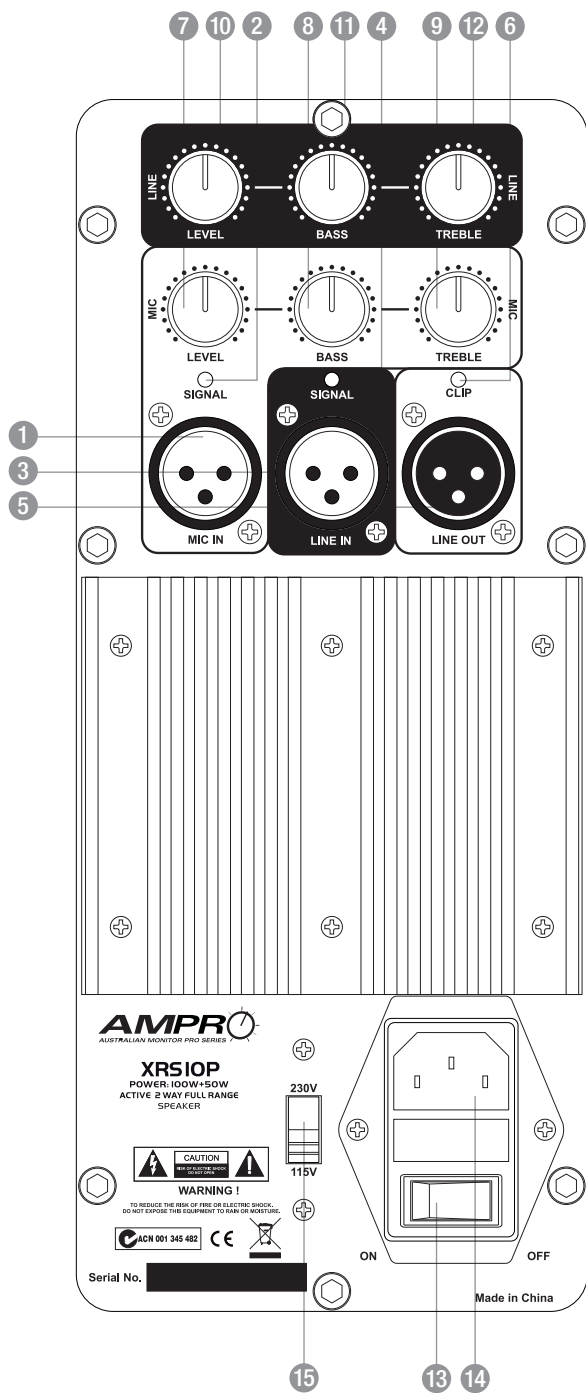

1 MIC IN

This is a balanced XLR microphone input.

2 Mic SIGNAL

This is a green LED signal present indicator for the Mic input. It indicates signal present on the input and is not affected by the level control.

3 LINE IN

This is a balanced XLR line level input.

4 Line SIGNAL

This is a green LED signal present indicator for the Line input. It indicates signal present on the input and is not affected by the level control.

5 LINE OUT

The LINE OUT is on an XLR connector. This output can be connected to the LINE IN on another XRS Powered speaker to expand the system.

6 Output CLIP

This is a red LED clip indicator for the mixed mic and line audio signal. Some flashing of red is acceptable on program transients. Continuous flashing of red could be placing undue stress on the speaker and will sound distorted. Turn down the input level until the clip LED is no longer lit.

7 Mic LEVEL

This controls the level of the MIC input (1).

8 Mic BASS

This is the bass control for the MIC input (1). There is 12dB of cut and boost at 100Hz. This EQ is the shelving type.

9 Mic TREBLE

This is the treble control for the MIC input (1). There is 10dB of cut and boost at 10kHz. This EQ is the shelving type.

10 Line LEVEL

This controls the level of the LINE input. (3)

11 Line BASS

This is the bass control for the LINE input (3). There is 12dB of cut and boost at 100Hz. This EQ is the shelving type.

12 Line TREBLE

This is the treble control for the LINE input (3). There is 10dB of cut and boost at 10kHz. This EQ is the shelving type.

13 Power Switch

This switch turns the power on or off to the unit.

14 IEC Mains Input Socket

This is a standard IEC 3 pin socket. It accepts a standard IEC mains cable, (provided). The fuse draw contains the mains fuse and a spare.

The mains fuse is a time lag (slow blow) HRC 20mm x 5mm ceramic or glass type fuse.

XRS8P	XRS10P	XRS12P
2.5A	2.5A	5.0A

! IMPORTANT: Always replace the fuse with one of the same value and type.

⚡ NOTE: Always disconnect power to the amplifier before replacing fuses.

15 Voltage Select Switch

This switch is used to select the mains voltage for your region. Select either 230V or 115V.

! IMPORTANT: Disconnect power to the amplifier before operating this switch.

! IMPORTANT: Make sure this setting is correct before connecting the unit to the mains.

SPECIFICATIONS

	XRS8P	XRS10P	XRS12P
Drivers	1 x 8" woofer 1 x 1.5" HF driver	1 x 10" woofer 1 x 1.5" HF driver	1 x 12" woofer 1 x 2" HF driver
Frequency Response(-3dB)	65Hz-18kHz	55Hz-18kHz	50Hz-18kHz
Frequency Response(-10dB)	55Hz-18kHz	50Hz-18kHz	40Hz-20kHz
Peak Sound Level(dB 1m)	118dB	121dB	125dB
Tone controls			
Bass control @ 100Hz	12dB	12dB	12dB
Treble control @ 10kHz	10dB	10dB	10dB
Output Power	100W(low) + 50W(high)	100W(low) + 50W(high)	300W(low) + 100W(high)
Distortion (THD)			
Line	0.02%	0.02%	0.02%
Microphone	0.04%	0.04%	0.04%
Tweeter Dispersion(HxV)	90° x 90°	90° x 90°	90° x 90°
Input Impedance			
Line	20kOhm	20kOhm	20kOhm
Microphone	10kOhm	10kOhm	10kOhm
Connectors	XLR 3	XLR 3	XLR 3
Power Supply	AC 115V/230V, 50/60Hz	AC 115V/230V, 50/60Hz	AC 115/230V, 50/60Hz
Dimensions(WxDxH)	277 x 265 x 407mm	325 x 308 x 478mm	415 x 391 x 600mm
Packing Dimensions(WxDxH)	355 x 325 x 470mm	375 x 355 x 535mm	465 x 435 x 680mm
Net Weight	8.6kg	10.5kg	23kg
Gross Weight	10.1kg	11.8kg	25.2kg

	XRS8	XRS10	XRS12
Drivers	1 x 8" woofer 1 x 1.5" HF driver	1 x 10" woofer 1 x 1.5" HF driver	1 x 12" woofer 1 x 2" HF driver
Frequency Response(-3dB)	65Hz-18kHz	55Hz-18kHz	50Hz-18kHz
Frequency Response(-10dB)	60Hz-20kHz	50Hz-20kHz	40Hz-20kHz
Sensitivity(dB 1W 1m)	92 dB	95 dB	97 dB
Impedance	8 Ohm	8 Ohm	8 Ohm
Recommended Max Power(Wrms)	100 W	250 W	300 W
Max Sound Level(dB 1m)	118dB	125dB	128dB
Dispersion(HxV)	90° x 90°	90° x 90°	90° x 90°
Harmonic Distortion	1%	1%	1%
Speakon compatible connectors	1	2	2
Dimensions(WxDxH)	277 x 257 x 400mm	321 x 321 x 464mm	415 x 382 x 620mm
Packing Dimensions(WxDxH)	595 x 310 x 460mm	375 x 355 x 535mm	465 x 435 x 680mm
Net Weight	6.5kg	10kg	18kg
Gross Weight	15kg (pair)	12kg	20kg

AUSTRALIA AND NEW ZEALAND

www.australianmonitor.com.au

SYDNEY

(NSW SALES)

1 Clyde Street
Silverwater
NSW 2128
Private Bag 149
Silverwater NSW 1811
Phone: (02) 9647 1411
Fax: (02) 9648 3698
Email:
nsw@audiotelex.com.au

MELBOURNE

(VIC & TAS SALES)

22/277
Middleborough Road
Box Hill VIC 3128
PO Box 151 Blackburn
South VIC 3130
Phone: (03) 9890 7477
Fax: (03) 9890 7977
Email:
vic@audiotelex.com.au

ADELAIDE

(SA & NT SALES)

31 Walsh Street
Thebarton
SA 5031
PO Box 157
Hindmarsh SA 5007
Phone: (08) 8352 4444
Fax: (08) 8352 4488
Email:
sa@audiotelex.com.au

AUCKLAND

(NZ SALES)

9C Piermark Drive
Albany 0752
New Zealand
PO Box 300-512
Albany 0752
Phone: (09) 415 9426
Fax: (09) 415 9864
Email:
nz@hillssvl.co.nz

CANBERRA

(ACT SALES)

1st Floor,
Campion Street
Deakin ACT 2600
PO Box 109
Deakin West ACT 2600
Phone: (02) 6260 4544
Fax: (02) 6260 4744
Email: gordon.anderson@hillssvl.com.au

BRISBANE

(QLD SALES)

42 Commercial Road
Fortitude Valley
QLD 4006
PO Box 2578 Fortitude
Valley BC QLD 4006
Phone: (07) 3852 1312
Fax: (07) 3252 1237
Email:
qld@audiotelex.com.au

PERTH

(WA SALES)

3/11 Howe Street
Osborne Park WA 6017
PO Box 1281
Osborne Park BC
WA 6916
Phone: (08) 9204 0200
Fax: (08) 9244 3783
Email:
wa@audiotelex.com.au

EUROPE / ASIA / MIDDLE EAST

www.australianmonitor.com.au

INTERNATIONAL SALES

1 Clyde Street Silverwater NSW 2128 Australia
Private Bag 149 Silverwater NSW 1811
Phone: + 61 2 9647 1411
Fax: + 61 2 9748 2537
Email: international@audiotelex.com.au

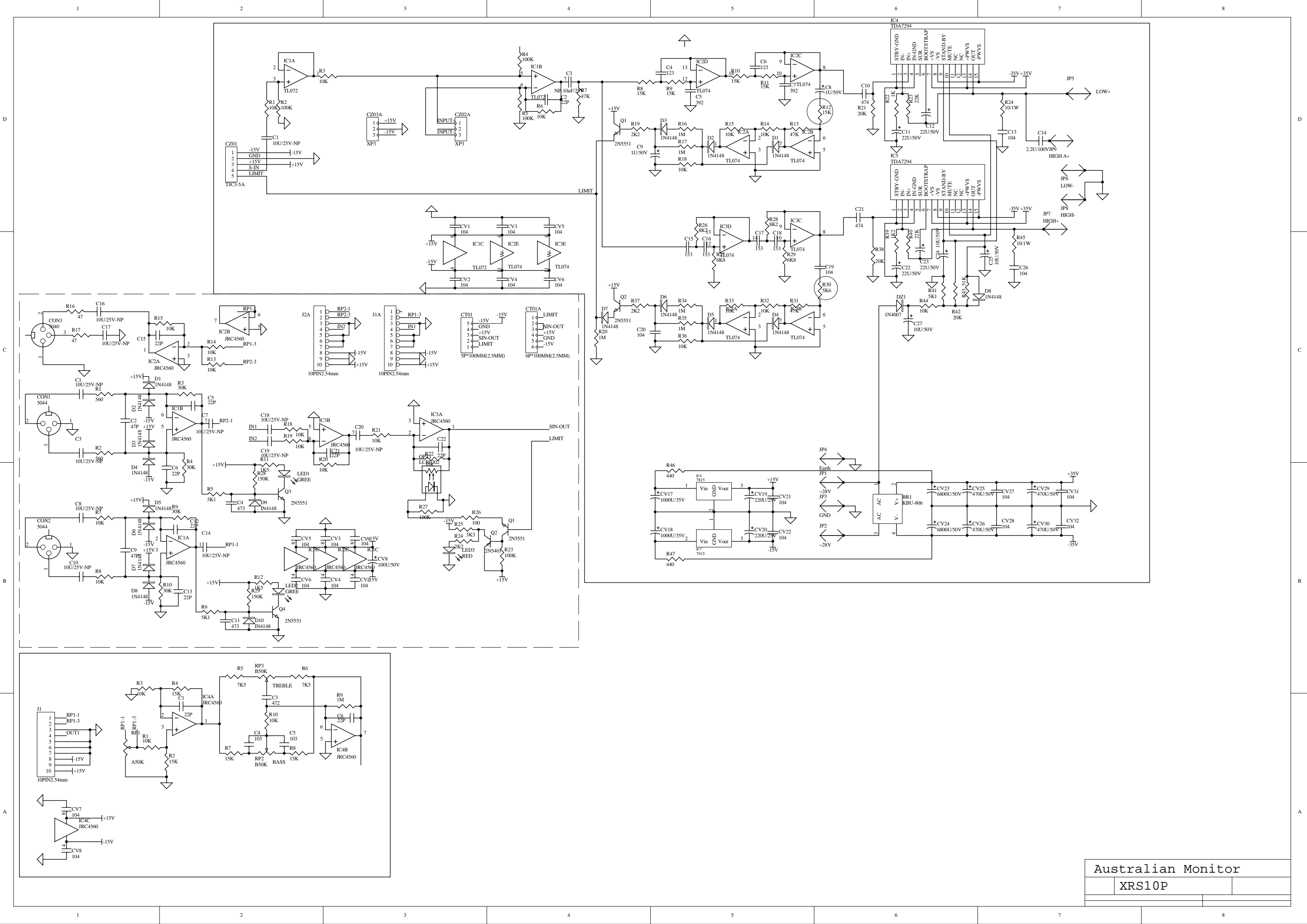

Australian Monitor
XRS10P