

# SCHEMATIC CIRCUIT DIAGRAM - ARMSTRONG A20

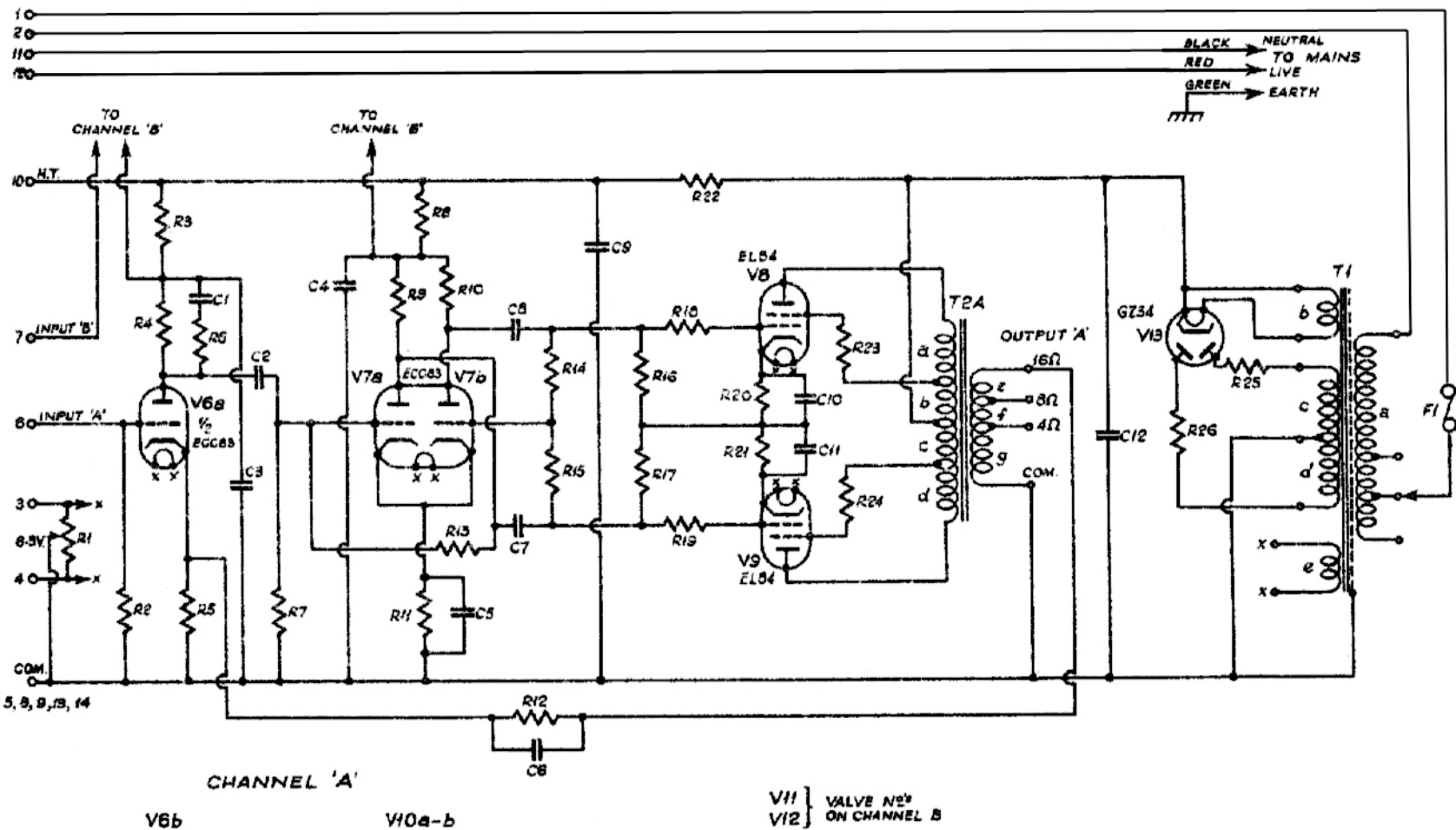

POWER AMPLIFIER A20

LAYOUT DIAGRAMS

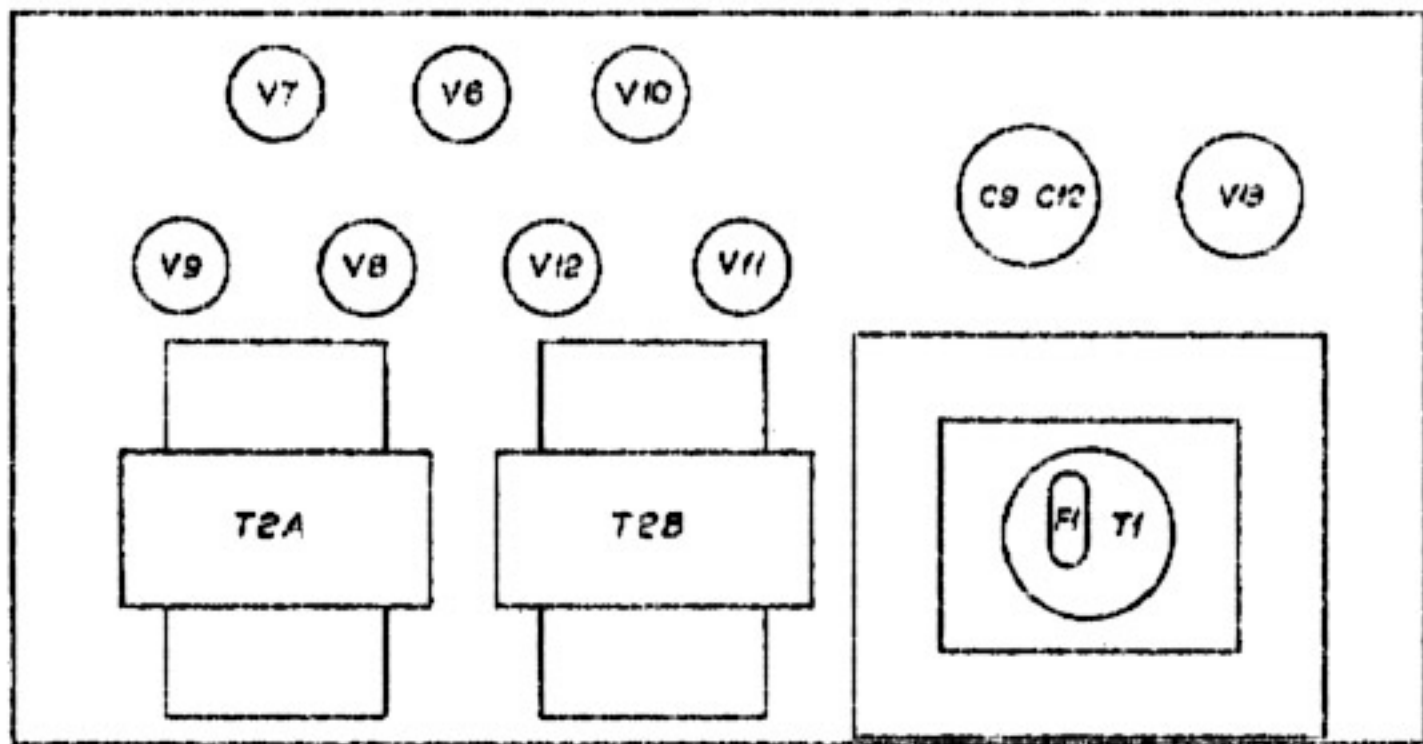

TOP VIEW

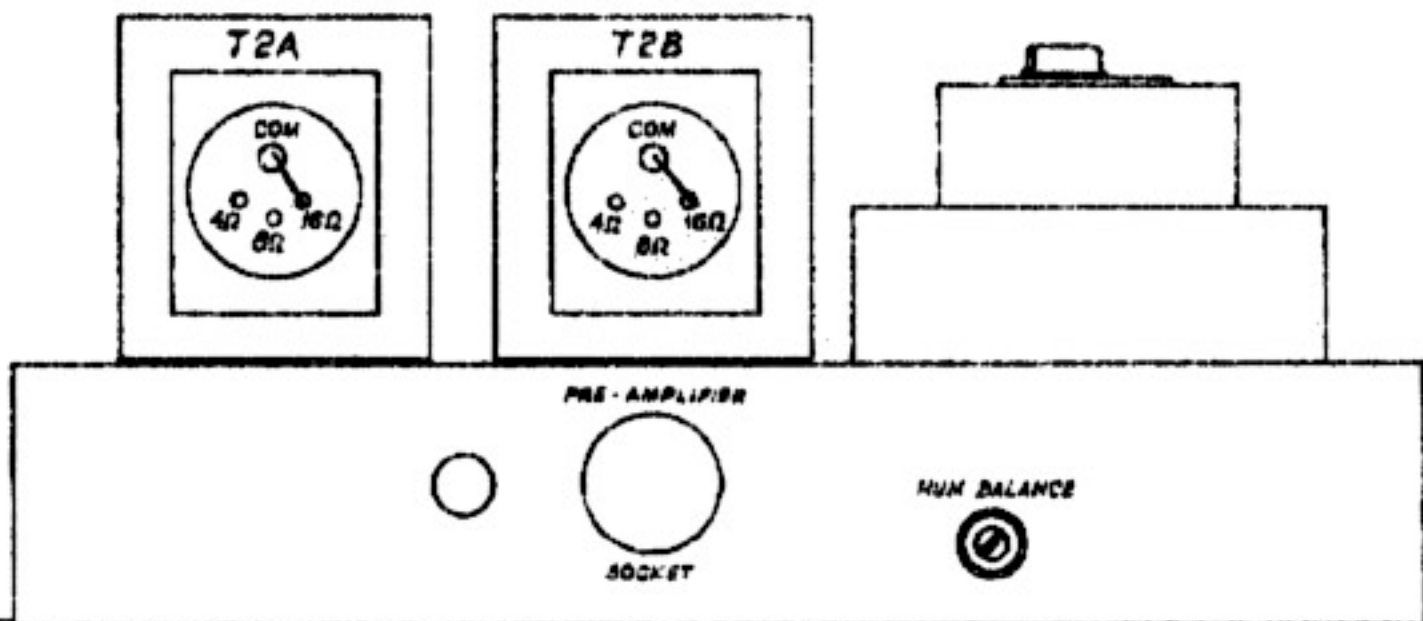

REAR VIEW

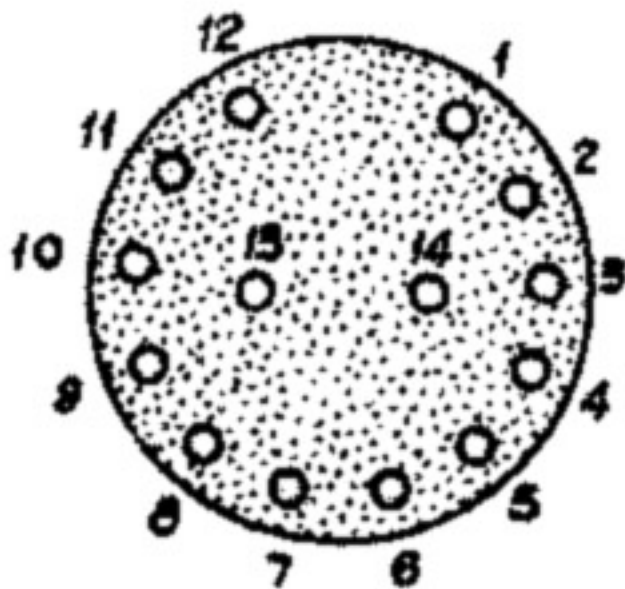

CONNECTING PLUG LOOKING AT  
PIN ENDS, OR SOCKET LOOKING  
AT REAR.

VALVE BASE DIAGRAMS

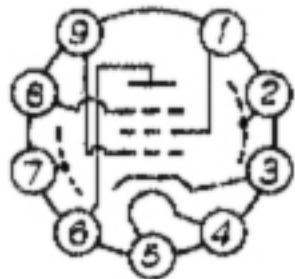

EF86

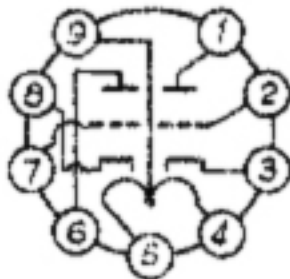

ECC83

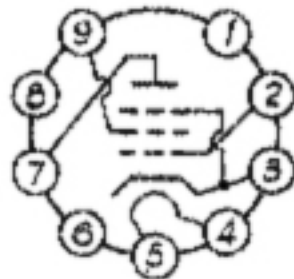

EL84

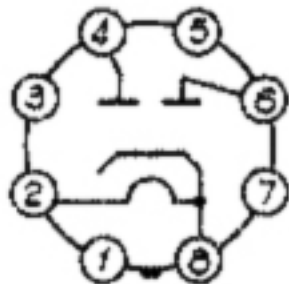

GZ34